

LISTEN.
THINK.
SOLVE.SM

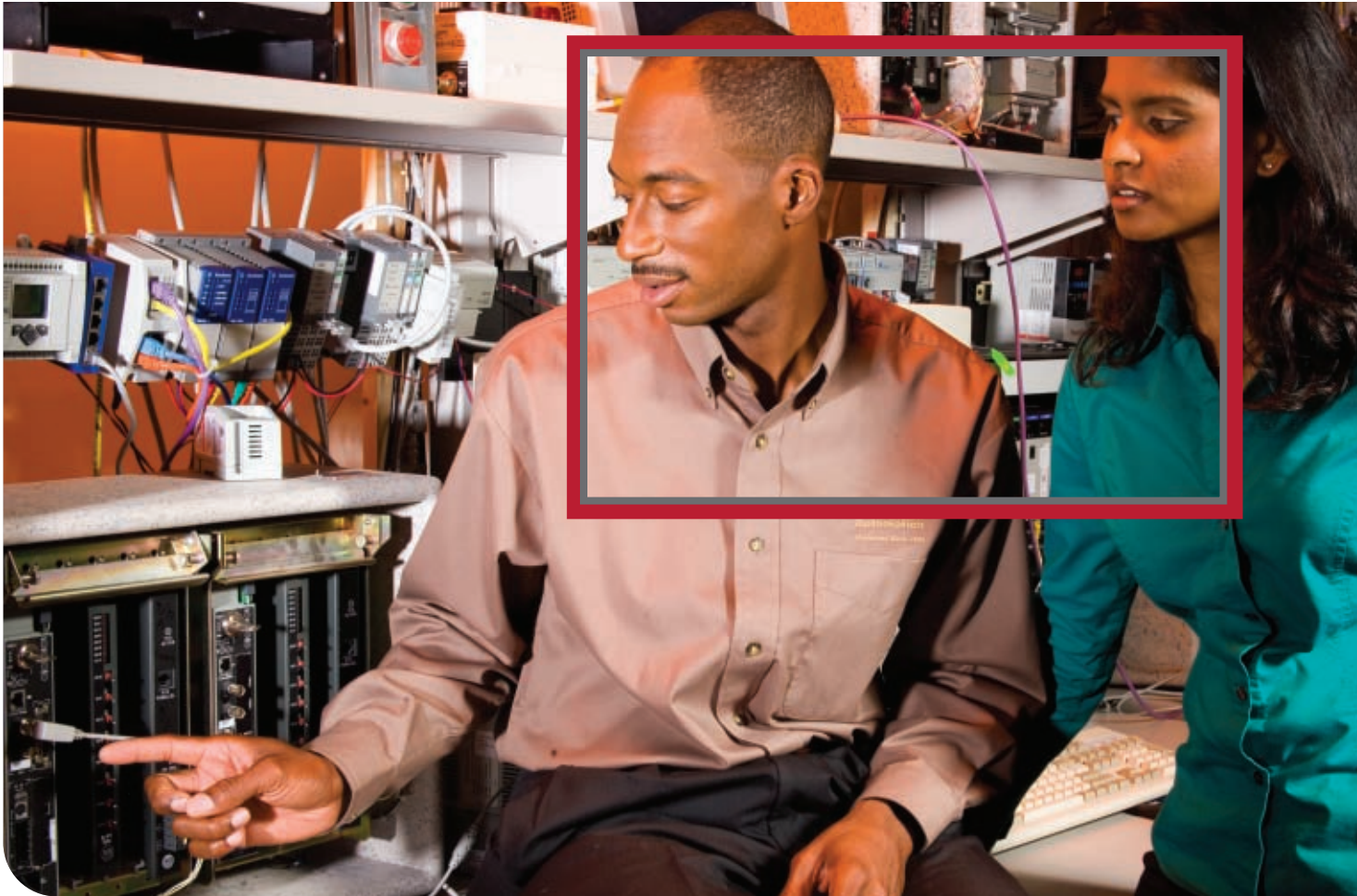

PLC-5 PROGRAMMABLE CONTROLLERS

SELECTION GUIDE 1785 and 1771



PLC-5 Programmable Controllers Comparison

Category	Controller	Catalog Number	User Memory Words, Max	Total I/O, Max	Number of Communication Ports (mode)
Standard	PLC-5/11	1785-L11B	8000	512	1 DH+ or Remote I/O (Adapter or Scan)
	PLC-5/20	1785-L20B	16,000	512	1 DH+ and 1 DH+ or Remote I/O (Adapter or Scan)
	PLC-5/30	1785-L30B	32,000	1024	2 DH+ or Remote I/O (Adapter or Scan)
	PLC-5/40	1785-L40B	48,000	2048	4 DH+ or Remote I/O (Adapter or Scan)
	PLC-5/40L	1785-L40L	48,000	2048	2 DH+ or Remote I/O (Adapter or Scan) and 1 Extended Local I/O
	PLC-5/60	1785-L60B	64,000	3072	4 DH+ or Remote I/O (Adapter or Scan)
	PLC-5/60L	1785-L60L	64,000	3072	2 DH+ or Remote I/O (Adapter or Scan) and 1 Extended Local I/O
	PLC-5/80	1785-L80B	100,000	3072	4 DH+ or Remote I/O (Adapter or Scan)
Standard with Protected Memory	PLC-5/26	1785-L26B	16,000	512	1 DH+ and 1 DH+ or Remote I/O (Adapter or Scan)
	PLC-5/46	1785-L46B	48,000	2048	4 DH+ or Remote I/O (Adapter or Scan)
	PLC-5/86	1785-L86B	100,000	3072	4 DH+ or Remote I/O (Adapter or Scan)
ControlNet	PLC-5/20C	1785-L20C15	16,000	512	1 ControlNet (Dual Media) and 1 DH+
	PLC-5/40C	1785-L40C15	48,000	2048	1 ControlNet (Dual Media) and 2 DH+ or Remote I/O (Adapter or Scan)
	PLC-5/80C	1785-L80C15	100,000	3072	1 ControlNet (Dual Media) and 2 DH+ or Remote I/O (Adapter or Scan)
ControlNet with Protected Memory	PLC-5/46C	1785-L46C15	48,000	2048	1 ControlNet (Dual Media) and 2 DH+ or Remote I/O (Adapter or Scan)
Ethernet	PLC-5/20E	1785-L20E	16,000	512	1 Ethernet, 1 DH+ and 1 DH+ or Remote I/O (Adapter or Scan)
	PLC-5/40E	1785-L40E	48,000	2048	1 Ethernet, 2 DH+ or Remote I/O (Adapter or Scan)
	PLC-5/80E	1785-L80E	100,000	3072	1 Ethernet, 2 DH+ or Remote I/O (Adapter or Scan)

Introduction

1785 PLC-5 Programmable Controller: The Foundation of Control Architecture

The PLC-5 programmable controller stands at the center of a control architecture that brings together existing and future systems by means of networks such as EtherNet/IP, ControlNet and DeviceNet, and offers connectivity among SLC 500, ControlLogix, and MicroLogix controllers. Because they include embedded network connections, PLC-5 controllers enable your control architecture to be flexible enough to include cost-effective connections to a wide range of devices.



Controllers
Information, Control, and Device Communication Capability

I/O Modules
Many Choices to Meet Your Exact Requirements

Software Tools
Program in Structured Text, Function Block, Sequential Function Charts or Ladder Logic Languages

Topic	Page
PLC-5 System Overview	2
Lay Out the System	4
Select I/O Modules	7
Select Network Communications	19
Select Controllers	31
Select Chassis	37
Select Power Supplies	39
Select Software	43
ViewAnyWare Products	50
Summary	53

PLC-5 System Overview

A PLC-5/1771 control system, at minimum, consists of a programmable controller and I/O modules in a single 1771 chassis with a power supply. You choose the controller with the on-board communication ports you need.

A simple system can consist of only a standalone controller and I/O modules all in a single chassis

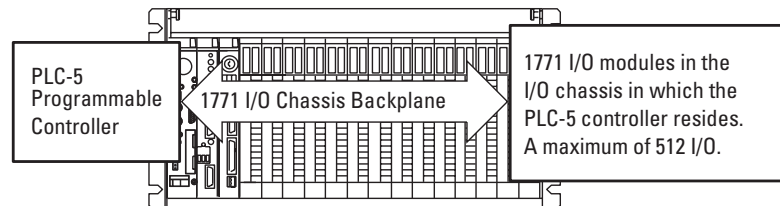

On-board remote I/O scanner ports are available on all PLC-5 controllers. On-board extended-local I/O scanner ports are available on some PLC-5 controllers. On-board ControlNet ports are available on some PLC-5 controllers. To provide a DeviceNet I/O scanner port to the system, you must add a 1771-SDN DeviceNet Scanner Module.

In the typical configuration illustration, a ControlNet port on the controller interfaces the processor to the ControlNet link. In each of the two chassis remote from the controller, a 1771-ACN15 I/O Adapter Module provides I/O modules in those chassis with an interface to the ControlNet link. In this configuration, the PLC-5 controller monitors/controls the I/O in its local I/O chassis as well as the I/O in the remote locations.

Multiple controllers can communicate across networks; and I/O in multiple platforms can be distributed in many locations connected over multiple I/O links

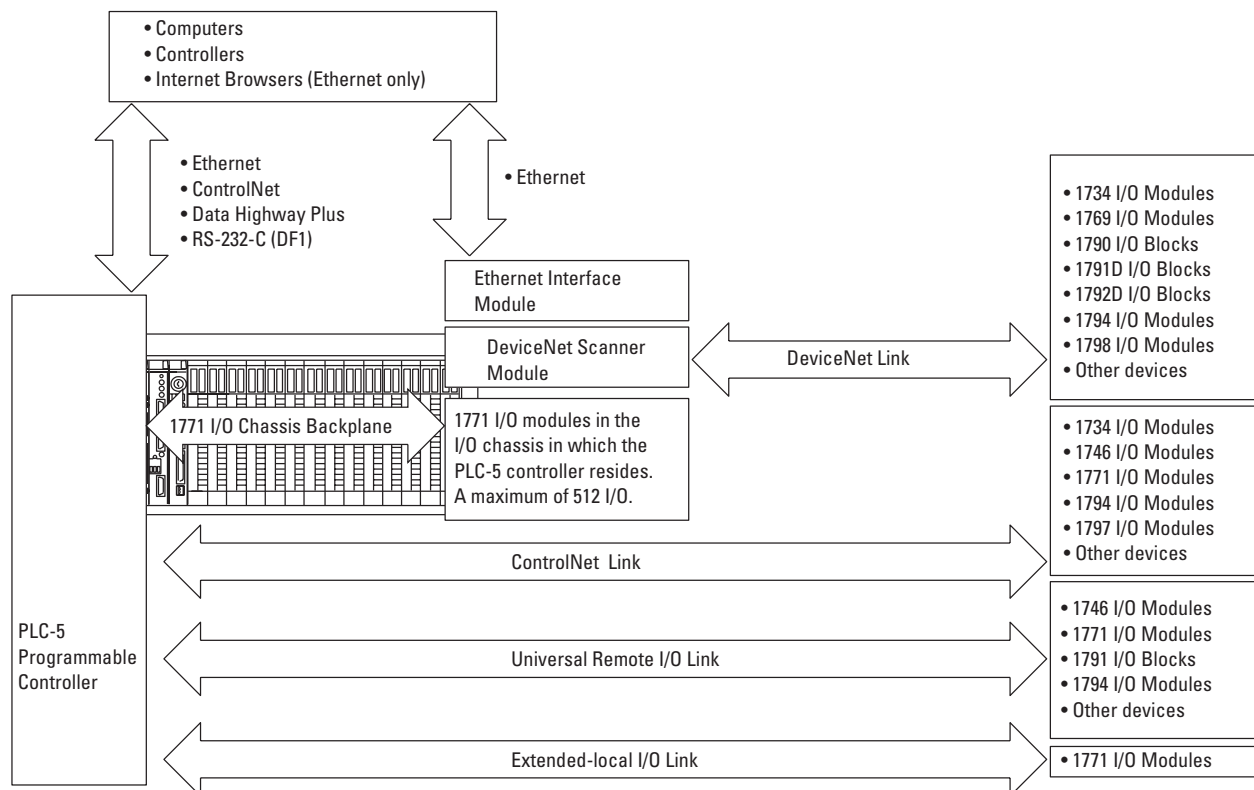

Plug a 1771 power supply module into an I/O module slot, or connect a standalone 1771 power supply into the left end of each chassis.

Depending on the communication ports available on your particular PLC control system, you can select operator interfaces that are compatible with those particular ports.

Lay Out the System

Lay out the system by determining the network configuration and the placement of components in each location. Decide at this time whether each location will have its own controller.

Place each controller's I/O on an isolated network to maximize the performance and to more easily accommodate future network or system configuration changes. If you plan to share I/O, make sure the I/O is on a network that each controller can access.

Assume that Network A and Network B both require a controller and its I/O. Both controllers interact with time-critical information.

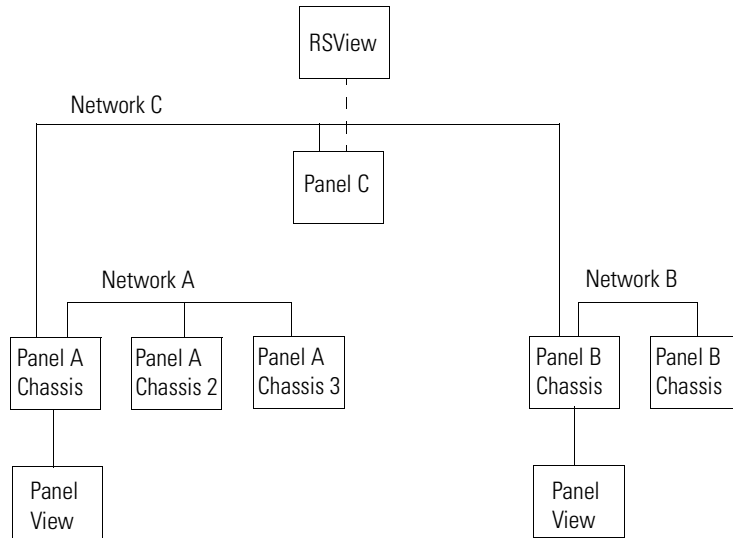

For a PLC-5 controller to control I/O modules, both the controller and the I/O modules must be directly attached to the same network.

I/O Location	Controller in Panel A, Chassis 1	Controller in Panel B, Chassis 1
Panel A, chassis 1	Yes	Yes
Panel A, chassis 2	Yes	No
Panel A, chassis 3	Yes	No
Panel B, chassis 1	Yes	Yes
Panel B, chassis 2	No	Yes
Panel C, chassis 1	Yes	Yes

Evaluate what communications need to occur between controllers. If there is sporadic information that is not time-critical, use a message-based network such as an EtherNet/IP (the information portion), Data Highway Plus, or the unscheduled portion of the ControlNet network. If the information is time-critical, such as producer/consumer tags between controllers, use the ControlNet or EtherNet/IP network.

Apply Backup Solutions

The ControlNet Hot Backup Module, 1785-CHBM, provides backup of ControlNet I/O. A secondary controller qualifies critical-control information with the primary controller. Both controllers consume information from inputs and connect to outputs, but only the primary controller controls the outputs. The secondary controller establishes control of outputs if the primary controller shuts down.

For more information, see page 23.

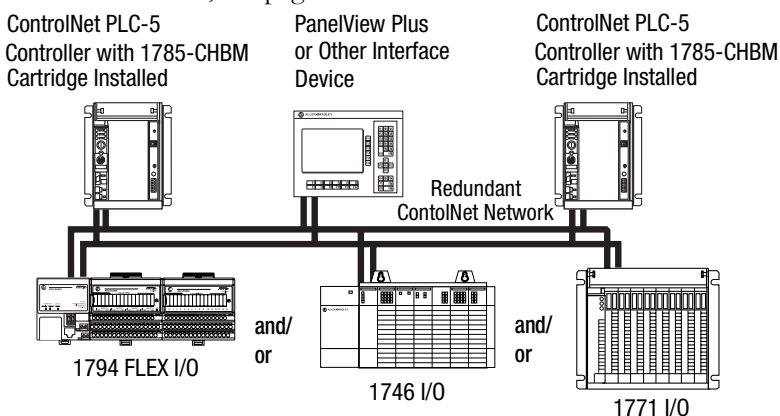

The PLC-5 Backup Communication Module, 1785-BCM, helps increase the fault tolerance of PLC-5 programmable controller systems controlling I/O on a remote I/O link by providing backup of the PLC-5 programmable controller.

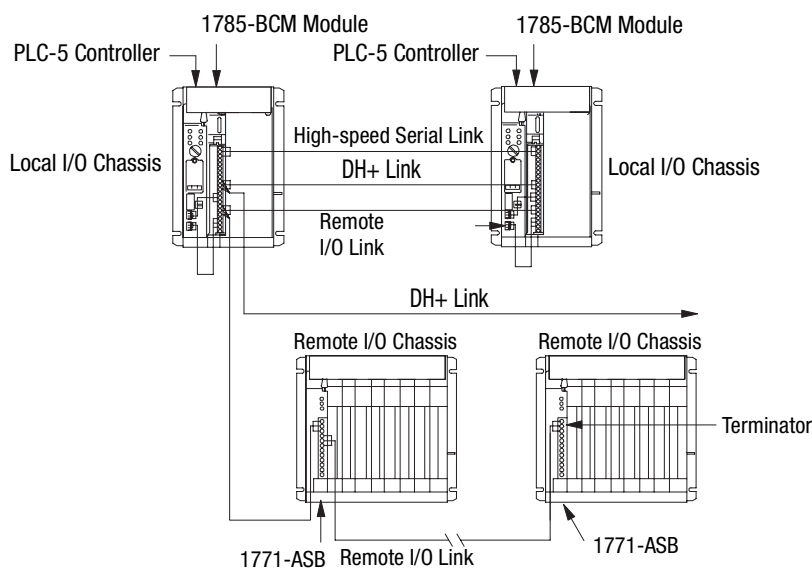

Cat. No.	Connections	Customer Relay	Design Considerations	Power Dissipation	Backplane Current Load
1785-BCM	1771-WG wiring arm (included)	0.25 A @ 24V dc (resistive)	Place in local I/O chassis	10 W max	1 A

Use the following checklist as a guide to completing your own system specification. The inside of the back cover of this selection guide is a worksheet you can use to record your selections.

✓	Step	For more information, see
<input type="checkbox"/>	1 Select I/O Modules Select I/O based on: <ul style="list-style-type: none"> • type of information to send/receive. • application requirements. • electrical requirements. 	1771 I/O Modules page 8 1746 I/O Modules page 13 1794 I/O Modules page 14 1797 I/O Modules page 15 1791D I/O Modules page 16 1734 I/O Modules page 17
<input type="checkbox"/>	2 Select Network Communications Select Networks based on: <ul style="list-style-type: none"> • type of information to send/receive. • system performance. • distance/size of application. • available networks. • future expansion. 	NetLinx Architecture page 19 Select a Network page 20 EtherNet/IP Protocol page 21 ControlNet page 23 DeviceNet page 25 Serial Network page 26 Data Highway Plus page 29 Remote I/O page 30
<input type="checkbox"/>	3 Select Controllers Select a controller based on: <ul style="list-style-type: none"> • I/O requirements. • memory requirements. • communication requirements. 	Enhanced Controllers page 32 Ethernet Controllers page 33 ControlNet Controllers page 34 Protected Controllers page 35 Backing Up Memory page 36 Battery Replacement page 36
<input type="checkbox"/>	4 Select Chassis Select a chassis based on: <ul style="list-style-type: none"> • the number of slots you need. 	1771 Chassis page 37 Mounting Dimensions page 38
<input type="checkbox"/>	5 Select Power Supplies Select a power supply based on: <ul style="list-style-type: none"> • input voltage. • output current. • number of slots required. 	1771 Power Supplies page 39 Power Requirements and Transformer Sizing page 40
<input type="checkbox"/>	7 Select Software Select software based on: <ul style="list-style-type: none"> • computer platform. • operating environment. • programming language. 	Select Software page 43 Programming Software page 44 RSLinx Software page 45 Network Configuration Software page 46 RSLogix Emulate 5 Software page 47 PLC-5 and Training Software page 48 ViewAnyWare Products page 50

Select I/O Modules

Step 1 - Select:

- 1771 I/O Modules
- 1746 I/O Modules
- 1794 FLEX I/O Modules
- 1797 FLEX Ex I/O Modules
- 1791D CompactBlock I/O Modules
- 1734 POINT I/O Modules
- Encompass Partner Program I/O Modules

Rockwell Automation offers many types of I/O modules and has more than 3 million modules installed in applications worldwide. Rockwell Automation offers chassis-based and both block and modular-distributed modules.

The following sections outline the available I/O modules. For more information about these I/O modules, see the Allen-Bradley I/O Module Brochure, publication ACIG-BR002, or visit the Rockwell Automation Distributed I/O Web page at <http://www.ab.com/io>.

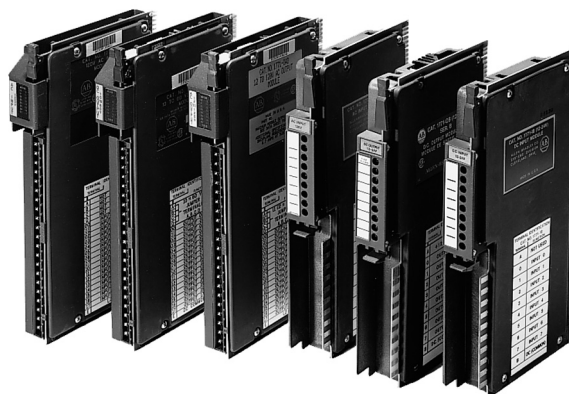

If your application requires preferred I/O for PLC-5, and	Use this type of I/O	On any of these networks
<ul style="list-style-type: none"> • Native I/O providing highest performance • Is chassis-based and needs to accommodate a wide range of I/O types • Controls an entire process • Is a master/slave configuration for distributed control 	1771 I/O see page 8	<ul style="list-style-type: none"> - ControlNet - Remote I/O - Extended Local I/O
If your application	Use this type of I/O	On any of these networks
<ul style="list-style-type: none"> • Is chassis-based and requires different types of I/O • Has smaller size requirements than 1771 • Communicates with SLC controllers 	1746 I/O see page 13	<ul style="list-style-type: none"> - ControlNet - Remote I/O - Extended Local I/O
<ul style="list-style-type: none"> • Has distributed control that requires multiple types of I/O devices near a machine 	1794 FLEX I/O see page 14	<ul style="list-style-type: none"> - EtherNet/IP - ControlNet - DeviceNet - Remote I/O - Extended Local I/O - PROFIBUS DP
<ul style="list-style-type: none"> • Has distributed control in a hazardous area 	1797 FLEX Ex I/O see page 15	<ul style="list-style-type: none"> - ControlNet via coax or fiber - DeviceNet via bus isolator - EtherNet/IP via bus isolator - PROFIBUS DP via bus isolator
<ul style="list-style-type: none"> • Requires rackless design with panel or DIN-rail mounting • Requires modular, high-density I/O 	1769 Compact I/O see page 15	<ul style="list-style-type: none"> - DeviceNet - Local I/O
<ul style="list-style-type: none"> • Has distributed control • Must have I/O mounted near sensors or actuators • Uses motor starters, solenoids, or indicators 	1791D I/O CompactBlock I/O see page 16	<ul style="list-style-type: none"> - DeviceNet - Remote I/O - PROFIBUS DP
<ul style="list-style-type: none"> • Requires high modularity • Requires flexibility and low-cost of ownership 	1734 POINT I/O see page 17	<ul style="list-style-type: none"> - DeviceNet - ControlNet - EtherNet/IP - PROFIBUS DP
<ul style="list-style-type: none"> • Requires functionality not delivered in Rockwell Automation products 	Encompass Partners Program products, see page 18	Multiple

1771 I/O Modules

The 1771 series I/O modules offer digital, analog, and special-requirement modules. The 1771 I/O modules feature a wide range of:

- signal interfaces to ac and dc sensors and actuators.
- I/O densities with as many as 32 I/O points per module.
- signal levels, including standard analog inputs and outputs and direct thermocouple and RTD temperature inputs.

PLC-5 controllers support 1771 I/O over these networks:

- Local I/O
- Remote I/O
- Extended-local I/O
- ControlNet

When you select 1771 I/O modules, you must also select:

- Chassis
- Power supply
- Adapter module (if in remote chassis or extended-local chassis)

1771 Digital Input Modules

Category	Cat. No.	Inputs and Outputs	Voltage	Backplane Current Load
TTL	1771-IG	8 in	--	122 mA
	1771-IGD	16 in	--	130 mA
24V dc Sink Source Load	1771-IB	8 in	10...27V	74 mA
	1771-IBD	16 in	10...30V	250 mA
	1771-IBN	32 in	10...30V	280 mA
	1771-IT	8 in	12...24V	74 mA
	1771-IQ	8 in	5...30V	150 mA
	1771-IQ16	16 in	10...32V isolated	100 mA
	1771-IS	72 in	5V multiplexer	800 mA
	1771-DW	7 in	15...27 wire fault	300 mA
	1771-DS	8 in	10...27V latching	375 mA
	48V dc Sink Source Load	1771-IC	8 in	42...56V
1771-IH		8 in	24...50V	74 mA
24V dc Source Sink Load	1771-IV	8 in	12...24V	74 mA
	1771-IVN	32 in	10...30V	280 mA
	1771-IQ	8 in	5...30V	150 mA
	1771-IQ16	16 in	10...32V isolated	100 mA
24V ac	1771-IN	8 in	12...28V	80 mA
	1771-IND	16 in	16...30V ac 9...30V dc	250 mA

Category	Cat. No.	Inputs and Outputs	Voltage	Backplane Current Load
120V ac/dc	1771-ID	6 in	92...38V isolated	74 mA
	1771-IAD	16 in	79...138V	195 mA
	1771-ID16	16 in	77...138V ac 105...138V dc isolated	75 mA
	1771-IA	8 in	87...138V ac 97...138V dc	75 mA
120V ac	1771-IAN	32 in	85...138V	280 mA
220V ac/dc	1771-ID01	6 in	184...276V ac/dc	74 mA
	1771-IM	8 in	184...276V ac/dc	75 mA

1771 Digital Output Modules

Category	Cat. No.	Inputs and Outputs	Voltage	Backplane Current Load
TTL	1771-OG	8 in	5.0...5.3V	168 mA
	1771-OGD	16 in	5.0...5.3V	230 mA
24V dc Sink	1771-OVN	32 out	10...30V	330 mA
	1771-OQ16	16 out	10...32V isolated	400 mA
24V dc Source	1771-OQ	8 out	20.4...26.4V isolated	225 mA
	1771-OQ16	16 out	10...32V isolated	400 mA
	1771-OB	8 out	10...27V	165 mA
	1771-OB0	16 out	10...60V	300 mA
	1771-OBN	32 out	10...30V	330 mA
48V dc Source	1771-OC	8 out	42...53V	165 mA
24V ac	1771-ON	8 out	20...30V	225 mA
120V ac	1771-OP	4 out	92...138V protected	350 mA
	1771-OD	6 out	92...138V isolated	225 mA
	1771-ODZ	8 out	92...138V isolated	350 mA
	1771-ODD	16 out	85...138V isolated	420 mA
	1771-OA	8 out	92...138V	210 mA
	1771-OD16	16 out	74...138V isolated	200 mA
	1771-OAD	16 out	10...138V	295 mA
120/240V ac	1771-OAN	32 out	80...265V	800 mA
220V ac	1771-OR	6 out	184...276V isolated	255 mA
	1771-OM	8 out	184...250V	225 mA

Category	Cat. No.	Inputs and Outputs	Voltage	Backplane Current Load
24-120V ac/dc Relay Contact	1771-OW	8 out	24...138V ac resistive load 24-125V dc	700 mA
	1771-OW16	16 out	24...250V ac isolated 24...150V dc isolated	1.3 A
	1771-OWN	32 out	24...138V ac 24...125V dc	2.5 A
	1771-OWNA	32 out	24...138V ac resistive load 24-125V dc	2.5 A
	1771-OX	4 out	0...250V ac isolated inductive load 0...175V dc isolated	550 mA
0-24V ac/dc	1771-OYL	8 out	0...24V ac/dc	420 mA
	1771-OZL	8 out	0...24V ac/dc	420 mA

1771 Analog Input Modules

Category	Cat. No.	Inputs and Outputs	Range: Voltage and Current	Backplane Current Load
Selectable	1771-IFE	8 differential or 16 single	± 10 V dc ± 20 mA	750 mA
	1771-IFF	8 differential or 16 single	± 10 V dc ± 20 mA	750 mA
	1771-IL	8 differential, isolated	± 10 V dc ± 20 mA	1.3 A
	1771-IE	8 single	± 10 V dc	500 mA
	1771-NIV	8 in	± 5 V dc ± 2 0mA	1.5 A
	1771-NIV1	8 in	± 10 V dc ± 20 mA	1.5 A
Voltage Only	1771-IFMS	8 differential	0...50 mV	750 mA
Current Only	1771-NIS	8 in isolated	4...20 mA	2.9 mA
Thermocouple	1771-IXE	8 floating differential	± 99.99 mV	750 mA
	1771-IXHR	8 floating differential	± 99.99 mV	750 mA
	1771-NT1	8 mV/TC	± 100 mV	1.5 A
	1771-NT2	8 mV/TC	-5/+55 mV dc	1.5 A
RTD	1771-IR	6 in	RTD	800 mA
	1771-NR	8 in	RTD isolated	1.5 A
Mixed	1771-NIVR	4V/current in	± 5 V dc ± 20 mA	1.5 A
	1771-NIVT	4V/current and 4 mV/TC in	± 5 V dc for volt/current ± 20 mA ± 100 mV for mV/TC	1.5 A

1771 Analog Output Modules

Category	Cat. No.	Inputs and Outputs	Range: Voltage and Current	Backplane Current Load
Selectable	1771-OFE1	4 out	$\pm 10V$ dc	1.5 A
Current Only	1771-OFE2	4 out	4...20 mA	1.5 A
	1771-OFE3	4 out	0...50 mA	2.5 A
	1771-NOC	8 out	0...25 mA	2.9 A at 20 mA 3.3 A at 25 mA
Voltage Only	1771-NOV	8 out	$\pm 10V$ dc	2.1 A

1771 Analog Combination Modules

Category	Cat. No.	Inputs and outputs	Range: Voltage and Current	Backplane Current Load
Selectable Voltage	1771-NBV1	6 in 2 out	$\pm 10V$ dc ± 20 mA	1.8 A
Selectable Current	1771-NBVC	6 in 2 out	$\pm 5V$ dc/ ± 20 mA 0...25 mA	1.8 A
Current	1771-NB4S	2 in 2 out isolated	4...20 mA 0...25 mA	1.6 A
	1771-NBSC	6 in 2 out isolated	4...20 mA 0...25 mA	3.0 A
RTD	1771-NB4T	2 in 2 out	mV/TC ± 100 mV 0...25 mA	1.5 A
	1771-NBRC	6 in 6 out	RTD 0...25 mA	1.8 A
	1771-NBTC	6 in 2 out	mV/TC ± 100 mV 0...25 mA	1.6 A

1771 Intelligent Modules

Category	Cat. No.	Use	Backplane Current Load
Counter	1771-IJ	Incremental encoder/counter	1.2 A
	1771-IK	High-speed counter	1.2 A
	1771-VHSC	Very high speed counter	0.65 A
	1771-DE	Absolute encoder	0.8 A
	1771-DL	Gray encoder	0.12 A
Positioning	1771-QA	Stepper motor positioning	0.8...2.4 A
	1771-QB	Linear positioning	1.6 A
	1771-QC	Servo positioning	1.75 A
	1771-M3	Servo controller	1.75 A
	1771-ES	Servo encoder feedback expander	1.7 A
	1771-M1	Stepper motor controller	1.75 A
	1771-QD	Injection molding	0.5 A
	1771-QDC	Plastic molding	1.2 A
	1771-QH	Force control	1.2 A
	1771-HS	IMC 120 motion control	0.72 A
	1771-HS1	IMC 121 motion control	1.06 A
	1771-HS3	IMC 123 motion control	1.06 A
	1771-HRA	Resolver excitation	0.065 A
Flow	1771-CFM	Configurable flowmeter	1.0 A
Specialty	1771-PM	Clutch/brake control	1.2 A
	1771-SIM	I/O simulator	0.2 A
	1771-DR	High-speed logic	1.1 A
	1771-PD	PID control	1.2 A
	1771-DC	Real-time clock	
	1771-DB	BASIC	0.65 A without DH-485 0.75 A with DH-485
	1771-LC	Loop control	
Temperature	1771-TCM	Temperature control	1.5 A
Hydraulic	1771-QH	High-speed transparent transition	1.2 A
Plastics	1771-QDC	Plastic molding	1.2 A
	1771-QI	Co-injection	1.2 A

For more information about the family of 1771 I/O modules, see the following publications.

Publication Title	Publication Number
1771 Digital I/O ac Input and Output Modules Product Data	1771-2.182
1771 Analog Input and Output Modules Product Data	1771-2.183
1771 Digital I/O dc Input and Output Modules Product Data	1771-2.180

1746 I/O Modules



The 1746 I/O modules (SLC 500 I/O) provide a cost-effective, Remote I/O option. Use an SLC 500 Remote I/O module (1747-ASB) or ControlNet adapter module (1747-ACN15 or -ACNR15) to directly interface 1746 I/O modules to the PLC-5 system. The 1746 I/O modules feature:

- high-density, 32-point and combination modules, which reduce rack size and panel space requirements.
- removable terminal blocks and 16-point modules, which simplify wiring and replacing modules.
- industrial design, including input filtering and optical isolation.

PLC-5 controllers support 1746 I/O over these networks:

- Remote I/O
- ControlNet

When you select 1746 I/O modules, you must also select:

- Chassis
- Power supply
- Cabling components
- Adapter module, if in remote chassis or extended-local chassis

For more information, see the following publications.

Publication Title	Publication Number
SLC 500 System Overview	1747-SG001
SLC Analog I/O Modules Technical Data	1746-TD001
SLC Modular Chassis and Power Supplies Technical Data	1746-TD003

1794 FLEX I/O Modules

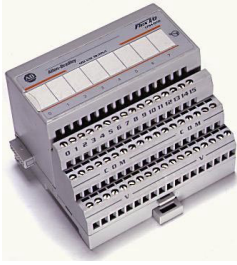

FLEX I/O is a cost-effective, flexible, modular I/O system for distributed applications and offers all the functions of larger rack-based I/O without the space requirements. You can independently select the I/O type, termination, and network, appropriate for your specific application. This means one I/O product line can fit all your needs. The 1794 FLEX I/O modules feature:

- modular design, which reduces costs by solving a large range of application requirements with one I/O architecture.
- small size, which reduces packaging costs.
- individual wire-termination locations, which reduce purchasing costs and complexity, as well as packaging costs.
- diagnostics and removal and insertion under power (RIUP), which lowers the mean time to repair equipment and leverages your control investment.
- flexible communications, which helps to control future costs by providing an economical migration path.

PLC-5 controllers support 1794 I/O over these networks:

- Remote I/O
- ControlNet
- DeviceNet

For more information about 1794 FLEX I/O, see the FLEX I/O and FLEX Ex I/O Selection Guide, publication 1794-SG002.

1797 FLEX Ex I/O Modules



The 1797 series I/O modules (FLEX Ex I/O) are a flexible I/O system that mounts directly to the controlled equipment in a hazardous area. This eliminates the need for intrinsically safe (IS), barriers/isolators and separation of control and process. Additionally, the modules:

- offer modularity for distributed intrinsically-safe systems.
- have dual-fault protection IS circuits that provide high fault tolerance.
- have I/O circuitry that provides full IS field-device protection.

PLC-5 controllers support 1797 I/O over these networks:

- Remote I/O
- ControlNet
- DeviceNet

When you select 1797 FLEX Ex I/O modules, you must also select:

- adapter module and cabling components.
- bus isolator module and cabling components.
- terminal base unit.
- DIN rail.
- power supply.

For more information about 1797 FLEX Ex I/O, see the FLEX I/O and FLEX Ex I/O Selection Guide, publication 1794-SG002.

1791D CompactBlock I/O Modules



The 1791D I/O modules (CompactBlock I/O) are designed for applications that require I/O to be distributed close to sensors and actuators or to be placed in small enclosures. The modules feature:

- self-contained package that provides cost-effective distribution of up to 32 points per node.
- small size that lets you install in shallow and confined areas.
- hardware watchdog circuit.
- DeviceLogix Smart Component Technology that provides limited I/O logic for intelligent I/O block.

PLC-5 controllers support 1791D I/O over these networks:

- Remote I/O
- DeviceNet
- PROFIBUS DP

When you select 1791D I/O modules, the I/O circuits, a built-in power supply, and a Remote I/O adapter are included. You must select an enclosure and cabling components.

For more information about 1791D CompactBlock I/O, see the 1791D Block I/O Technical Data, publication 1791D-TD001.

1734 POINT I/O Modules

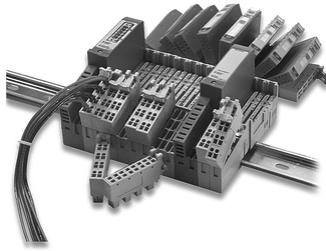

POINT I/O is a family of I/O modules that are ideal for applications where flexibility and low-cost of ownership are key for successful control system design and operation. POINT I/O can be used in remote device panels, local control panels, and can be accessed from many locations including the Internet. This product is just-what-you-need granularity in one to eight points to reduce system cost and size. POINT I/O modules feature:

- A highly modular design with 1 point to 8 point modularity
- Broad application coverage
- Parameter-level explicit messaging
- Removal and insertion under power
- Channel-level open-wire detection with electronic feedback
- Robust backplane design
- Built-in DIN-rail grounding

PLC-5 controllers support POINT I/O over these networks:

- DeviceNet
- ControlNet
- PROFIBUS DP

When you select POINT I/O modules, you must also select:

- A communication interface
- I/O devices based on field devices
- Wiring base assembly
- Power distribution modules

For more information about POINT I/O, see the POINT I/O Selection Guide, publication 1734-SG001.

Additional I/O Selections



The Encompass Partners Program, Rockwell Automation's third-party product referencing program, builds on the strengths of our products.

As a technology-sharing program, Encompass is product-based and application-focused. Encompass allows third-party companies to provide functionality not delivered in Rockwell Automation products. The following table lists additional I/O choices that are part of the Encompass program.

Encompass Partner	Products
Advanced Micro Controls, Inc.	<ul style="list-style-type: none"> • 1771 LDT Interface Module • 1771 Programmable Limit Switch • 1771 Resolver Interface Module
Ametek Automation and Process Technologies	Gemco Series 1771 Programmable Limit Switch
Hardy Instruments	1771-WS Weigh Scale Module
Hiprom Ltd.	1771 GPS Time Stamp Module
Miille Applied Research Company, Inc.	Dial Up and Leased Line Modems and Protocol Converters
Phoenix Digital Corporation	Optical Comm Modules for: <ul style="list-style-type: none"> • Ethernet • ControlNet • DF-1 • Data Highway • DH-485 • Modbus • RS-232 • RS-485
ProSoft Technology, Inc.	<ul style="list-style-type: none"> • "C" Programmable Solutions • AGA/API Flow Computers • HART • Honeywell DE Interface • Modbus Plus Communications-PLC • PLC Protocol Solutions • PLC Protocol Solutions-MVI
Spectrum Controls, Inc.	<ul style="list-style-type: none"> • High-density 32 Analog Input Module • 200V ac/dc Isolated 16 Input Module • 120/240V ac Isolated 16 Output Module
Weed Instrument	Fiber Optic Modems
Woodhead	PLC-5 Scanners for PROFIBUS DP

For more detailed information, refer to the Encompass product directory, publication 6873-QR004, or see www.rockwellautomation.com/encompass.

Select Network Communications

Step 2 - Select:

- EtherNet/IP Protocol
- ControlNet Network
- DeviceNet Network
- Serial Network
- Data Highway Plus
- Remote I/O

Use specific PLC-5 controllers with network connections and install multiple communication modules into the PLC-5 backplane to route control and information data between the different networks.

The networking capabilities, led by EtherNet/IP, ControlNet, and DeviceNet networks, allow information exchange between a range of devices and computing platforms and operating systems. PLC-5 controllers come with different network connections. Choose the network that best meets your needs.

NetLinx Architecture

NetLinx open network architecture is the Rockwell Automation strategy of using open networking technology for seamless, top-floor to shop-floor integration. The networks in the NetLinx architecture - DeviceNet network, ControlNet network and EtherNet/IP network - speak a common language and share a universal set of communication services. NetLinx architecture, part of the Integrated Architecture, seamlessly integrates all the components in an automation system from a few devices on one network to multiple devices on multiple networks including access to the Internet - helping you to improve flexibility, reduce installation costs, and increase productivity.

- EtherNet/IP network is an open industrial networking standard that supports implicit and explicit messaging and uses commercial, off-the-shelf Ethernet equipment and physical media.
- ControlNet network allows intelligent, high-speed control devices to share the information required for supervisory control, work-cell coordination, operator interface, remote device configuration, programming, and troubleshooting.
- DeviceNet network offers high-speed access to plant-floor data from a broad range of plant-floor devices and a significant reduction in wiring.

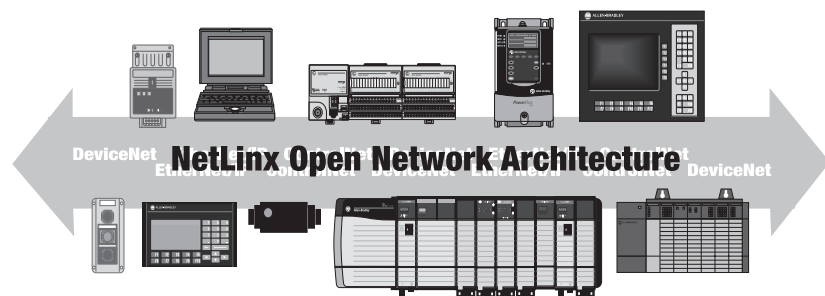

Select a Network

Configure your system for information exchange between a range of devices and computing platforms and operating systems.

If your application requires	Use this network	Select
<ul style="list-style-type: none"> High-speed data transfer between information systems and/or a large quantity of controllers Internet/intranet connection Program maintenance 	EtherNet/IP	<ul style="list-style-type: none"> 1785-L20E controller 1785-L40E controller 1785-L80E controller Applicable PLC-5 controller with 1785-ENET interface module
<ul style="list-style-type: none"> High-speed transfer of time-critical data between controllers and I/O devices Deterministic and repeatable data delivery Program maintenance Media redundancy or intrinsic safety options 	ControlNet	<ul style="list-style-type: none"> 1785-L20C15 1785-L40C15 1785-L80C15
<ul style="list-style-type: none"> Connections of low-level devices directly to plant floor controllers, without the need to interface them through I/O modules More diagnostics for improved data collection and fault detection Less wiring and reduced start-up time than a traditional, hard-wired system 	DeviceNet	PLC-5 controller with 1771-SDN scanner module
<ul style="list-style-type: none"> Plant-wide and cell-level data sharing with program maintenance 	Data Highway Plus	All PLC-5 controllers have at least one built-in, configurable Data Highway Plus channel
<ul style="list-style-type: none"> Connections between controllers and I/O adapters Distributed controllers so that each controller has its own I/O and communicates with a supervisory controller 	Remote I/O	All PLC-5 controllers have at least one built-in, configurable remote I/O channel
<ul style="list-style-type: none"> Modems Messages that send and receive ASCII characters to or from devices such as ASCII terminals, bar-code readers, message displays, weigh scales, or printers Supervisory control and data acquisition (SCADA) 	Serial Network	All PLC-5 controllers have one built-in serial port configurable for RS-232, RS-423, or RS-422A

EtherNet/IP Protocol

EtherNet/IP protocol is an open industrial-networking standard that supports implicit messaging (real-time I/O messaging), explicit messaging (messaging exchange), or both and uses commercial off-the-shelf Ethernet communication chips and physical media.

Additionally, EtherNet/IP standard uses the protocols used by the Internet. Both the PLC-5 and Ethernet Interface Module (1785-ENET) contain features that let you to use the Internet to access product information and to create and enhance application diagnostics.

Ethernet PLC-5 Controllers

Cat. No.	User Memory (words), Max	Total I/O, Max	Channels	Number of I/O Chassis, Max				Cable	Power Dissipation, Max	Backplane Current Load
				Total	Extended -local	Remote	ControlNet			
1785-L20E	16,000	512 any mix or 512 in + 512 out (complement)	1 Ethernet 1 DH+ 1 DH+/remote I/O	13	0	12	0	5810-TC02 or 5810-TC15	18.9 W	3.6 A
1785-L40E	48,000	2048 any mix or 2048 in + 2048 out (complement)	1 Ethernet 2 DH+/remote I/O	61	0	60	0	5810-TC02 or 5810-TC15	18.9 W	3.6 A
1785-L80E	100,000	3072 any mix or 3072 in + 3072 out (complement)	1 Ethernet 2 DH+/remote I/O	65	0	64	0	5810-TC02 or 5810-TC15	18.9 W	3.6 A

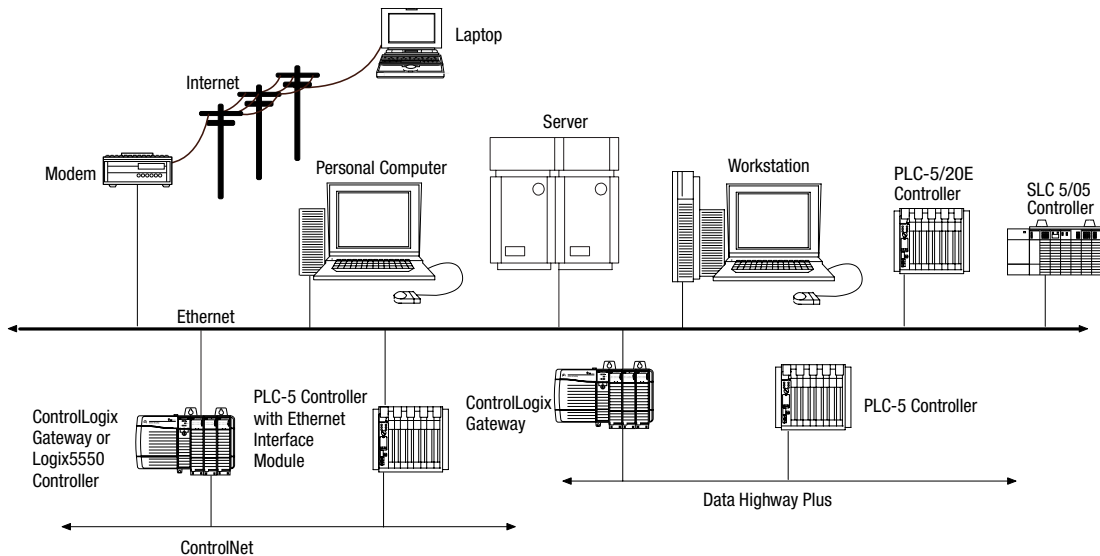



PLC-5 Ethernet Interface Module

The PLC-5 Ethernet Interface Module (1785-ENET) is a single-slot module that attaches to the side of any Enhanced PLC-5 series B or later controller, Ethernet PLC-5 controller, or ControlNet PLC-5 controller to provide additional Ethernet connectivity.

Cat. No.	When used with	The interface module provides
1785-ENET	Ethernet PLC-5 controller	Additional Ethernet connectivity by supporting dual Ethernet links
	Enhanced PLC-5 controller	Ethernet connectivity without sacrificing DH+ or remote I/O ports
	ControlNet PLC-5 controller	Dedicated Ethernet connectivity for plant and office integration

Using the Ethernet Interface Module’s built-in communication capabilities, your entire enterprise can use standard Ethernet or Internet connectivity to control and monitor production. Using the Internet and Web browser, you can create your own custom Web pages to provide executive summaries of process information. These pages are accessible to any Internet user who has network access to the PLC-5 controller. The embedded Web server provides access to PLC-5 diagnostics. Domain Name Service (DNS) and Simple Network Management Protocol (SNMP) are also supported.

Cat. No.	Comm. Rate	Connections	Design Considerations	Power Dissipation, Max	Backplane Current Load
1785-ENET	10/100 Mbps	64 TCP/IP connections 512 unsolicited definitions per module	Place in I/O chassis second leftmost slot attached to controller	11.5 W	2.2 A

ControlNet Network



ControlNet PLC-5 controllers offer embedded ControlNet communication capabilities for control and information processing. The ControlNet network provides both I/O control and peer-to-peer communications on a 5 Mbps network, with repeatability and determinism.

You can have multiple ControlNet PLC-5 controllers on one ControlNet network, with each controller handling its own I/O on the network, and at the same time communicating with each other. Multiple controllers can receive input data from one I/O or device node.

ControlNet PLC-5 Programmable Controllers

Cat. No.	User Memory (words), Max	Total I/O Max	Channels	Number of I/O Chassis, Max			ControlNet I/O Map Entries	Cable	Power Dissipation, Max	Backplane Current Load
				Total	Extended -local	Remote				
1785-L20C15	16,000	512 any mix or 512 in + 512 out (complement)	1 ControlNet 1 DH+ 1 DH+/remote I/O	77	0	12	64	1786-CP	15.8 W	3.0 A
1785-L40C15	48,000	2048 any mix or 2048 in + 2048 out (complement)	1 ControlNet 2 DH+/remote I/O	125	0	60	96	1786-CP	15.8 W	3.0 A
1785-L46C15 Protected	48,000	2048 any mix or 2048 in + 2048 out (complement)	1 ControlNet 2 DH+/remote I/O	125	0	60	96	1786-CP	15.8 W	3.0 A
1785-L80C15	100,000	3072 any mix or 3072 in + 3072 out (complement)	1 ControlNet 2 DH+/remote I/O	125	0	92	128	1786-CP	15.8 W	3.0 A

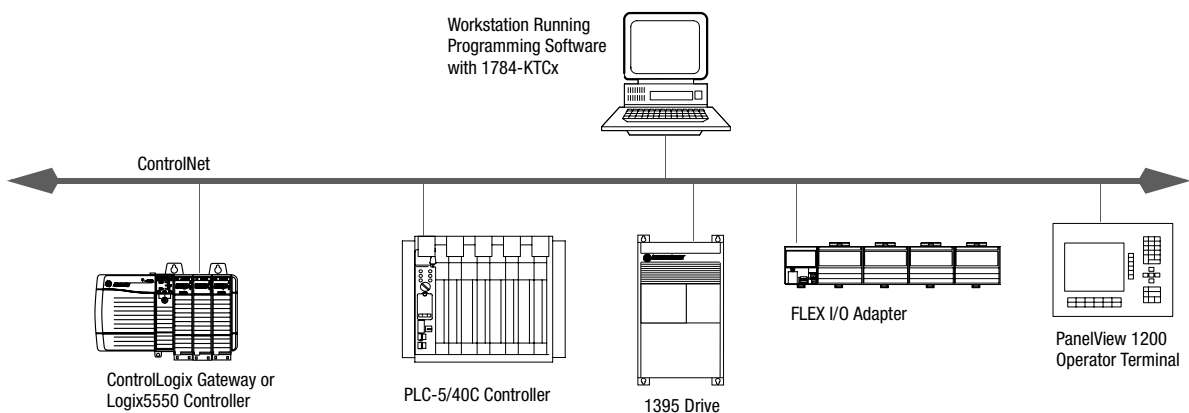

ControlNet Communication Adapters

Cat. No.	Function	Comm. Rate	Design Considerations	Cable	Power Dissipation, Max	Backplane Current Load
1734-ACNR	Interfaces POINT I/O modules in a POINTBus backplane to ControlNet controllers across a ControlNet network	5 Mbps	Requires a remote ControlNet PLC-5 controller, Series F, Revision E, or later.	Quad shield RG-6 coaxial cable	5.0 W	1.0 A
1747-ACN15, -ACNR15	Interfaces SLC I/O modules in an SLC chassis to a ControlNet scanner port across a ControlNet network	5 Mbps	Requires a remote ControlNet PLC-5 controller.	Quad shield RG-6 coaxial cable	5 W	900 mA
1771-ACN15, -ACNR15	Interfaces 1771 I/O modules in a 1771 chassis to a ControlNet scanner port across a ControlNet network	5 Mbps	Place in remote ControlNet chassis. Requires a ControlNet PLC-5 controller.	Quad shield RG-6 coaxial cable	5.2 W	1.0 A
1794-ACN15, -ACNR15	Interfaces FLEX I/O modules in a FLEX I/O rack to a ControlNet scanner port across a ControlNet network	5 Mbps	Requires a remote ControlNet PLC-5 controller.	Quad shield RG-6 coaxial cable	4.6 W	640 mA
1797- -ACNR15	Interfaces FLEX Ex I/O modules in a FLEX Ex rack to a ControlNet scanner port across a ControlNet network	5 Mbps	Requires a remote ControlNet PLC-5 controller.	Quad shield RG-6 coaxial cable	8.5 W	640 mA

ControlNet Hot Backup Module

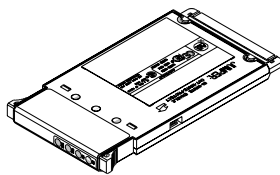

The ControlNet Hot Backup Module provides backup of ControlNet I/O. A secondary controller qualifies critical control information with the primary controller. Both controllers consume information from inputs and connect to outputs, but only the primary controller controls the outputs. The secondary controller establishes control of outputs if the primary controller shuts down.

ControlNet Hot Backup Basic System

Cat. No.	Quantity	Description
1785-CHBM	2	ControlNet Hot Backup Modules
1785-L40C15/F or 1785-L80C15/F ⁽¹⁾	2	ControlNet PLC-5 Programmable Controllers, Series F or later
1771-A1B through 1771-A4B	2	1771 I/O Chassis
1771-P4 through 1771-P10	2	1771 Power Supplies
1771-ACN(R)15, 1747-ACN(R), or 1794-ACN(R)	1	ControlNet Adapter
1784-KTCX15 or 1784-PCC card	1	Communication card for personal computer or laptop computer
9234 Series	1	RSLogix 5 Programming Software, version 3.22 or later
9357-CNETL3	1	RSNetWorx for ControlNet Software, version 1.80.xx or later
9234 Series	1	RSLink Gateway Communication Software, version 2.00.97.30 or later
Other System Requirements	ControlNet network cables, taps, and terminators for connections between the PLC-5 controllers and I/O adapters	

⁽¹⁾Both controllers must have the same series and firmware revision.

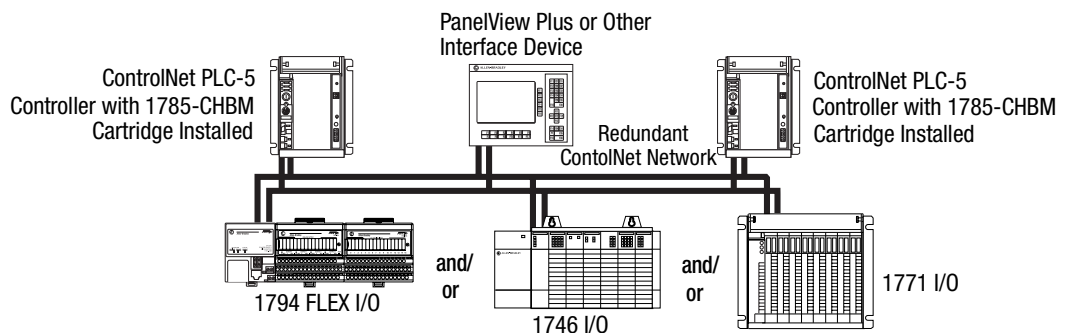

DeviceNet Network



The 1771-SDN DeviceNet scanner module acts as an interface between DeviceNet devices and a PLC-5 controller. The scanner module communicates with DeviceNet devices over the network to:

- read and write inputs and outputs to and from a device.
- download configuration data to a device.
- monitor operational status of a device.

The scanner module is a single-slot module that resides in a 1771 I/O chassis that either contains a PLC-5 controller or is on an extended-local I/O link, remote I/O link, or ControlNet network connected to a PLC-5 controller. The scanner module has Auto Device Replacement, change of state, cyclic I/O, pass-through, and Slave mode capability.

The number of PLC DeviceNet scanners that can reside in the same I/O chassis is limited only by the I/O chassis size, power supply capacity, and available memory.

Cat. No.	Function	Comm. Rate	Connections	Design Considerations	Cable	Power Dissipation, Max	Backplane Current Load
1771-SDN	Interfaces a local PLC-5 controller to a max of 2 DeviceNet networks	125 Kbps 250 Kbps 500 Kbps	63 connections per DeviceNet channel	Place in the local I/O chassis	1771-CD 10-pin linear plug, 1787-PLUG10R	6.3 W	1.2 A

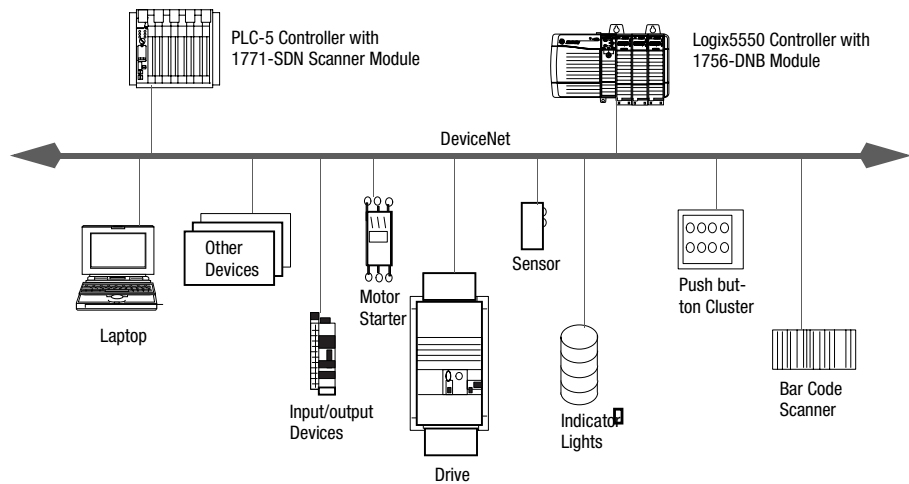

Serial Network

The PLC-5 serial port is configurable for RS-232, RS-423, or RS-422A compatible serial communication. Use the serial port to connect devices that:

- communicate using the DF1 protocol, such as modems, communication modules, programming workstations, or other serial devices.
- send and receive ASCII characters, such as ASCII terminals, bar-code readers, and printers.

When configured for System mode, the serial port supports the DF1 protocol. Use System mode to communicate with others devices on the serial link.

Use This DF1 Mode	For
Point-to-point	<ul style="list-style-type: none"> • Communication between a PLC-5 controller and other DF1-compatible devices. • In Point-to-Point mode, the PLC-5 controller uses DF1 full-duplex protocol.
DF1 Master	<ul style="list-style-type: none"> • Control of polling and message transmission between the master and each remote node. • In Master mode, the PLC-5 controller uses DF1 half-duplex polled protocol.
DF1 Slave	<ul style="list-style-type: none"> • Using the controller as a slave station in a master/slave serial network. • In Slave mode, the PLC-5 controller uses DF1 half-duplex protocol.

The serial port, in System mode, also supports supervisory control and data acquisition (SCADA) applications. SCADA systems let you monitor and control remote functions and processes using serial communication links between master and slave locations.

Cat. No.	Function	Comm. Rate	Connections	Design Considerations	Cable	Power Dissipation, Max	Backplane Current Load
1771-DA	Interfaces a PLC-5 controller and a peripheral device that generates ASCII characters	Configurable, depending on serial protocol	RS-232-C Current loop, 20 mA	Place in the local I/O chassis	Custom 26-pin cable ⁽¹⁾	6.8 W	1.3 A

⁽¹⁾ See the Enhanced and Ethernet PLC-5 Programmable Controllers User Manual, publication 1785-UM012.

The PLC BASIC Module occupies one slot in the 1771 I/O chassis and runs user-written BASIC and C programs. These programs are independent of your PLC-5 controller and provide an easy and fast interface between a PLC-5 controller, 1771 backplane, and RS-232, -422, or -485 devices. The module can also communicate with a remote SLC controller or remote device on the DH-485 network through a DH-485 port.

Cat. No.	Function	Comm. Rate	Connections	Design Considerations	Cable	Power Dissipation, Max	Backplane Current Load
1771-DB	Provides an interface between a PLC-5 controller, 1771 backplane, and RS-232, -422, or -485 devices	Configurable, depending on serial protocol	<ul style="list-style-type: none"> 2 ports for RS-232, -422, or -485 1 port for DH-485 	Place in the local I/O chassis	<ul style="list-style-type: none"> Data Highway 1770-CD RS-232 1770-CG or Modem Interface Cable 1770-CP 	4 W	0.75 A (with 1747-PIC) 0.65 A

The communication controller modules, 1771-KE and 1771-KF, link intelligent RS-232-C devices to Data Highway. Both of these modules provide a choice of two protocols on the RS-232-C link - full-duplex and half-duplex. These modules perform the same functions, however their mounting styles and power supply requirements are different.

Cat. No.	Function	Comm. Rate	Connections	Design Considerations	Cable	Power Dissipation, Max	Backplane Current Load
1771-KE	Provides an interface between RS-232-C devices and Data Highway link with both full-duplex and half-duplex protocols	<ul style="list-style-type: none"> Data Highway - 57 Kbps RS-232-C from 110 to 19 Kbps 	Data Highway, RS-232	Place in the local I/O chassis. Power source is the 1771 I/O chassis power supply.	<ul style="list-style-type: none"> Data Highway 1770-CD RS-232 1770-CG or Modem Interface Cable 1770-CP 	6.3 W	1.2 A
1771-KF	Provides an interface between RS-232-C devices and Data Highway link with both full-duplex and half-duplex protocols	<ul style="list-style-type: none"> Data Highway - 57 Kbps RS-232-C from 110 to 19 Kbps 	Data Highway, RS-232	Includes mounting bracket for external mounting or in a standard industrial enclosure (NEMA Type 12 or similar). Power source is user-supplied (1771-P2 or similar).	<ul style="list-style-type: none"> Data Highway 1770-CD RS-232 1770-CG or Modem Interface Cable 1770-CP 	6.3 W	1.2 A

When configured for User mode, the serial port supports ASCII devices. Use the PLC-5 ASCII instructions to send and receive information from these devices.

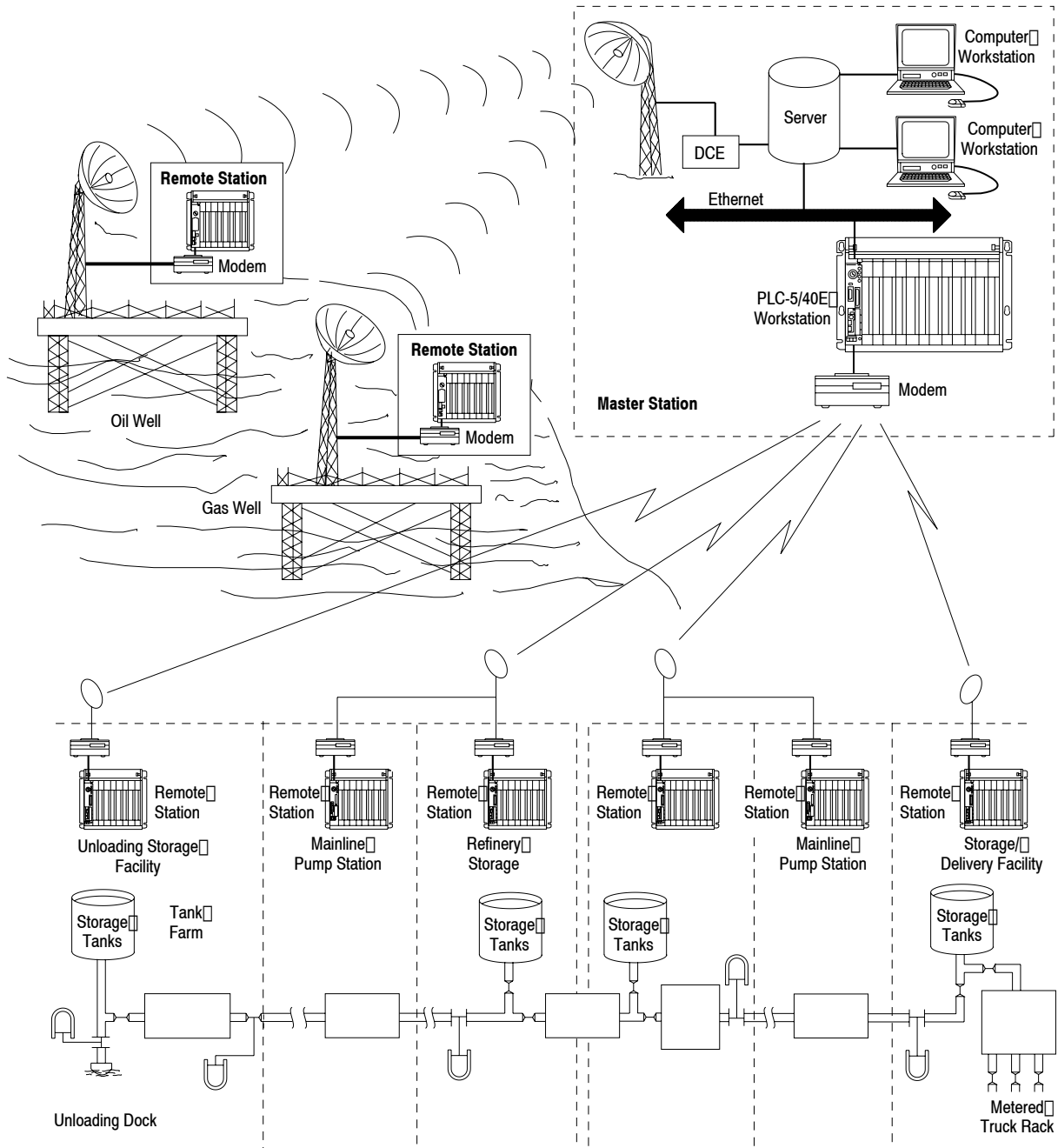

Data Highway Plus

The Data Highway Plus (DH+) network is a local area network designed to support remote programming and data acquisition for factory-floor applications. You can also use DH+ communication modules to implement a small peer-to-peer network.

You can use a DH+ network for data transfer to other PLC-5 controllers or high-level computers and as a link for programming multiple PLC-5 controllers. A PLC-5 controller can communicate over a DH+ network with other controllers and with a workstation.

The DH+ network supports daisy-chain and trunkline-dropline configurations.

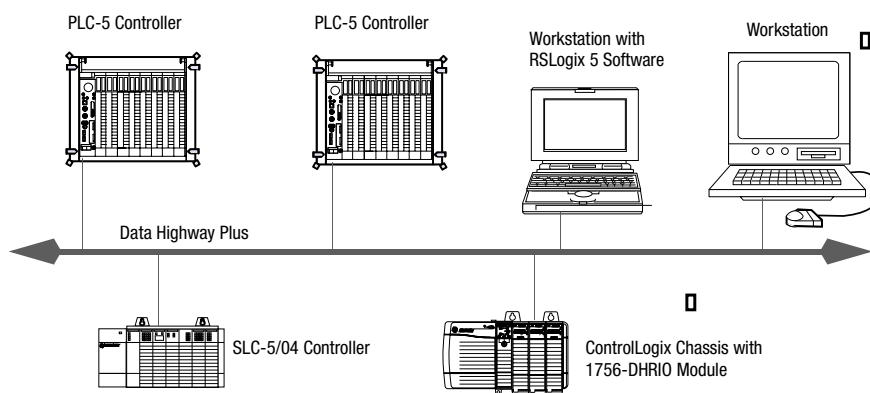

Cat. No.	Function	Comm. Rate	Connections	Design Considerations	Cable	Power Dissipation, Max	Backplane Current Load
1785-KA	Provides an interface between Data Highway Plus and Data Highway-485 link	<ul style="list-style-type: none"> DH+ 57 Kbps DH-485 configurable 	DH+ DH-485	Place in the local chassis	<ul style="list-style-type: none"> Data Highway 1770-CD RS-232 1770-CG or Modem Interface Cable 1770-CP 	10.5 W	2.0 A
1785-KE	Provides an interface between Data Highway Plus and RS-232-C link	<ul style="list-style-type: none"> DH+ 57 Kbps RS-232-C configurable 	DH+ RS-232-C	Place in the local chassis	<ul style="list-style-type: none"> Data Highway 1770-CD RS-232 1770-CG or Modem Interface Cable 1770-CP 	6.3 W	1.2 A

Remote I/O

The strength and versatility of the remote I/O network comes from the breadth of products it supports. In addition to 1771 I/O, the remote I/O network supports many Rockwell Automation and third-party devices.

Typical applications range from simple I/O links with controllers and I/O, to links with a variety of other devices. You connect devices through remote I/O adapter modules or built-in remote I/O adapters.

Using the remote I/O network instead of direct-wiring a device over a long distance to a local I/O chassis helps reduce installation, startup, and maintenance costs by placing the I/O closer to the sensors and actuators.

Some devices, like PLC-5 support Pass-Through, let you configure devices on a remote I/O network from an Ethernet, ControlNet, or Data Highway Plus network.

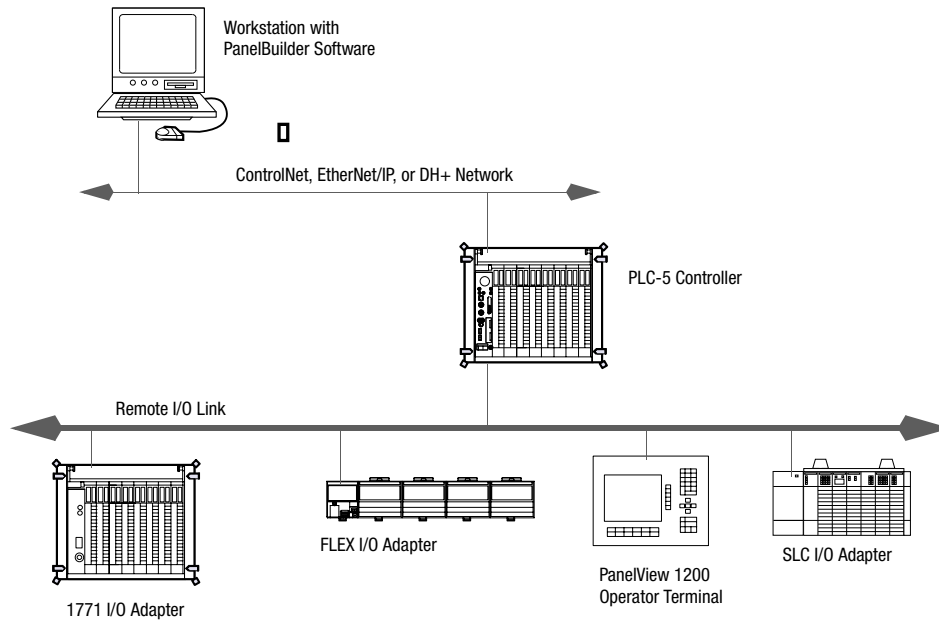

Cat. No.	Function	Comm. Rate	Connections	Design Considerations	Cable	Power Dissipation, Max	Backplane Current Load
1771-ASB	Interfaces I/O modules in an I/O chassis to a remote scanner port across a remote I/O link	57.6 Kbps 115 Kbps 230 Kbps	Remote I/O adapter port	Place in a remote chassis. Requires a PLC-5 controller that supports remote I/O	1770-CD Belden 9463	5.2 W	1.0 A
1771-DCM	Provides a remote I/O adapter port for a local PLC-5 controller to communicate with a remote I/O scanner port of a supervisory process across a remote I/O link	57.6 Kbps 115.2 Kbps	Remote I/O adapter port	Place in the local chassis	1770-CD Belden 9463	6.3 W	1.2 A

Select Controllers

Step 3 - Select:

- Enhanced PLC-5 Controllers
- Ethernet PLC-5 Controllers
- ControlNet PLC-5 Controllers
- Protected PLC-5 Controllers
- EEPROM Memory Modules
- Replacement Batteries

PLC-5 controllers are high-speed, single-slot controllers you can use for control and information processing. PLC-5 controllers are designed for larger sequential and regulatory control applications with specialized I/O requirements and/or the need to coordinate with other controllers and devices.

PLC-5 controllers come with different memory sizes and network connections. The Enhanced PLC-5 controllers offer a standard set of functions and communication options. The other PLC-5 controllers offer different communication options, while maintaining the same functions. Choose the controller that best meets your needs.

If your application requires	Select from
<ul style="list-style-type: none"> • Connectivity to a large number of Remote I/O devices • Connectivity to a large number of DH+ devices 	Enhanced PLC-5 Controllers see page 32
<ul style="list-style-type: none"> • EtherNet/IP connectivity • Communication with other Ethernet PLC-5 controllers and host computers 	Ethernet PLC-5 Controllers see page 33
<ul style="list-style-type: none"> • High-speed communication for control and information processing • Deterministic, repeatable data transfers • ControlNet connectivity 	ControlNet PLC-5 Controllers see page 34
<ul style="list-style-type: none"> • Limited access to critical or proprietary areas of programs • Selectively access to processor memory and I/O elements • Restricted use of processor operations 	Protected PLC-5 Controllers see page 35

Enhanced PLC-5 Controllers



Every PLC-5 controller offers built-in, configurable ports for Data Highway Plus (DH+) or Remote I/O. A DH+ connection supports remote programming and information access, in addition to peer-to-peer communication between the PLC-5, other controllers, and devices. A Remote I/O connection supports real-time data exchange for I/O, operator interface, and other third-party devices.

Cat. No.	User Memory (words), Max	Total I/O, Max	Channels	Number of I/O Chassis, Max				Power Dissipation, Max	Backplane Current Load
				Total	Extended -local	Remote	ControlNet		
1785-L11B	8000	512 any mix or 384 in + 384 out (complement)	1 DH+/remote I/O	5	0	4	0	12 W	2.3 A
1785-L20B	16,000	512 any mix or 512 in + 512 out (complement)	1 DH+ 1 DH+/remote I/O	13	0	12	0	12 W	2.3 A
1785-L30B	32,000	1024 any mix or 1024 in + 1024 out (complement)	2 DH+/remote I/O	29	0	28	0	12 W	2.3 A
1785-L40B	48,000	2048 any mix or 2048 in + 2048 out (complement)	4 DH+/remote I/O	61	0	32 max/link	0	17.3 W	3.3 A
1785-L60B	64,000	3072 any mix or 3072 in + 3072 out (complement)	4 DH+/remote I/O	93	0	32 max/link	0	17.3 W	3.3 A
1785-L80B	100,000	3072 any mix or 3072 in + 3072 out (complement)	4 DH+/remote I/O	93	0	32 max/link	0	17.3 W	3.3 A

Ethernet PLC-5 Controllers



The Ethernet PLC-5 controller integrates the Allen-Bradley architecture into an industry-standard EtherNet/IP system, offering a flexible and open solution.

With the Ethernet PLC-5 controller's built-in communication capabilities, your entire enterprise can use standard Ethernet or Internet connectivity to control and monitor production. Using the Internet and Web browser, you can create your own custom Web pages to provide executive summaries of process information. These pages are accessible to any Internet user who has network access to the PLC-5 controller. The embedded Web server provides access to PLC-5 diagnostics. Domain Name Service (DNS) and Simple Network Management Protocol (SNMP) are also supported.

Cat. No.	User Memory (words), Max	Total I/O, Max	Channels	Number of I/O Chassis, Max				Power Dissipation, Max	Backplane Current Load
				Total	Extended -local	Remote	ControlNet		
1785-L20E	16,000	512 any mix or 512 in + 512 out (complement)	1 Ethernet 1 DH+ 1 DH+/remote I/O	13	0	12	0	19 W	3.6 A
1785-L40E	48,000	2048 any mix or 2048 in + 2048 out (complement)	1 Ethernet 2 DH+/remote I/O	61	0	60	0	19 W	3.6 A
1785-L80E	100,000	3072 any mix or 3072 in + 3072 out (complement)	1 Ethernet 2 DH+/remote I/O	65	0	64	0	19 W	3.6 A

ControlNet PLC-5 Controllers



The ControlNet PLC-5 controller offers embedded ControlNet communication capabilities for control and information processing. The ControlNet network provides both I/O control and peer-to-peer communications on a 5 Mbps network, with repeatability and determinism.

You can have multiple ControlNet PLC-5 controllers on one ControlNet network, with each controller handling its own I/O on the network, and at the same time communicating with each other. Multiple controllers can receive input data from one I/O or device node.

Cat. No.	User Memory (words), Max	Total I/O, Max	Channels	Number of I/O Chassis, Max			ControlNet I/O Map Entries	Power Dissipation, Max	Backplane Current Load
				Total	Extended -local	Remote			
1785-L20C15	16,000	512 any mix or 512 in + 512 out (complement)	1 ControlNet 1 DH+ 1 DH+/remote I/O	77	0	12	64	15.8 W	3.0 A
1785-L40C15	48,000	2048 any mix or 2048 in + 2048 out (complement)	1 ControlNet 2 DH+/remote I/O	125	0	60	96	15.8 W	3.0 A
1785-L46C15 Protected	48,000	2048 any mix or 2048 in + 2048 out (complement)	1 ControlNet 2 DH+/remote I/O	125	0	60	96	15.8 W	3.0 A
1785-L80C15	100,000	3072 any mix or 3072 in + 3072 out (complement)	1 ControlNet 2 DH+/remote I/O	125	0	92	128	15.8 W	3.0 A

Protected PLC-5 Controllers



The Protected PLC-5 controller lets you limit access to critical or proprietary areas of programs, selectively guard controller memory and I/O, or restrict use of controller operations. The distinctive safety-yellow labels on the controller identify the protected PLC-5 controller.

Use the programming software to assign class privileges to specific user accounts or a user’s job function, such as system administrator, plant engineer, maintenance engineer, or operator. Using four privilege classes and associated passwords, you can limit access to critical areas of programs and restrict access to:

- communication channels.
- remote nodes attached to the ControlNet or DH+ network.
- program files.
- data files.

The protected PLC-5 controller expands system validity and security beyond that provided by the password-and-privilege feature of the other PLC-5 controllers. The Rockwell Automation clutch/brake application package combines the protected PLC-5 controller with specially-designed software to support stamping press applications.

Cat. No.	User Memory (words), Max	Total I/O, Max	Channels	Number of I/O Chassis, Max			ControlNet I/O Map Entries	Power Dissipation, Max	Backplane Current Load
				Total	Extended -local	Remote			
1785-L26B	16,000	512 any mix or 512 in + 512 out (complement)	1 DH+ 1 DH+/remote I/O	13	0	12	0	12 W	2.3 A
1785-L46B	48,000	2048 any mix or 2048 in + 2048 out (complement)	4 DH+/remote I/O	61	0	32 max/link	0	17.3 W	3.3 A
1785-L46C15 Protected	48,000	2048 any mix or 2048 in + 2048 out (complement)	1 ControlNet 2 DH+/remote I/O	125	0	60	96	15.8 W	3.0 A
1785-L86B	100,000	3072 any mix or 3072 in + 3072 out (complement)	4 DH+/remote I/O	93	0	32 max/link	0	17.3 W	3.3 A

Back Up Controller Memory

You can back up program files using an EEPROM module.

Cat. No.	Provides this amount of backup memory
1785-ME16 ⁽¹⁾	16,000 words
1785-ME32	32,000 words
1785-ME64	64,000 words
1785-CHBM	100,000 words

⁽¹⁾Not for use with ControlNet PLC-5 controllers.

Battery Replacement and Life Estimates

Cat. No.	Applies to	When used in this controller	At this temperature	Battery Life Estimate	
				Power off 100%	Power off 50%
1770-XYC	All PLC-5 Programmable Controllers	PLC-5/11, -5/20 and -5/20E	60 °C (140 °F)	256 days	1.4 years
			25 °C (77 °F)	2 years	4 years
		All Others	60 °C (140 °F)	84 days	150 days
			25 °C (77 °F)	1 year	1.2 years

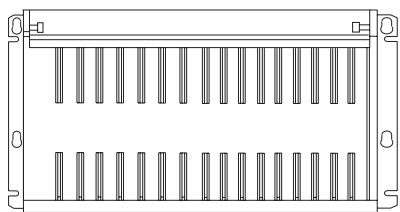

Select Chassis

Step 4 - Select Chassis:

- With the number of slots you need
- That meet your power supply requirements
- That meet your panel size and space limitations

The PLC-5 programmable controller requires a 1771 chassis to contain the various modules. Chassis are available in sizes of 1, 2, 4, 8, 12, and 16 module slots.

The backplane provides a communication path between the I/O modules and either the controller or the I/O adapter module.

The consistent size and mounting of the available 1771 chassis provide a universal configuration for system design and chassis-mounting configurations. If you anticipate that your system will expand, you may want to purchase a larger chassis for future expansion.

Cat. No.	Description	No. I/O Slots	Dimensions, Approx. (HxWxD)	Weight, Approx., kg (lb)	Mounting Type
1771-A1B	I/O chassis for 1771 I/O modules	4 slots	315 x 229 x 193 mm (12.4 x 9.0 x 7.6 in.)	3.6 (8.0)	Back-panel
1771-A2B	I/O chassis for 1771 I/O modules	8 slots	315 x 356 x 193 mm (12.4 x 14.0 x 7.6 in.)	4.7 (10.3)	Back-panel
1771-A3B	I/O chassis for 1771 I/O modules	12 slots	339 x 484 x 217 mm (13.5 x 19.0 x 8.5 in.)	3.6 (8.0)	19-in. rack or back-panel
1771-A3B1	I/O chassis for 1771 I/O modules	12 slots	315 x 483 x 193 mm (12.4 x 19.0 x 7.6 in.)	5.7 (12.6)	Back-panel
1771-A4B	I/O chassis for 1771 I/O modules	16 slots	315 x 610 x 193 mm (12.4 x 24.0 x 7.6 in.)	6.7 (14.8)	Back-panel
1771-PSC	Power-supply chassis (for connecting power directly or through a cable to an I/O chassis). Slots for installation of power supplies and modules requiring only power from the backplane.	4 slots	311 x 203 x 180 mm (12.2 x 8.0 x 7.1 in.)	1.9 (4.1)	Back-panel
1771-AM1	I/O chassis with integral remote I/O adapter and power supply (3 A available for I/O modules)	1 slot	298 x 70 x 187 mm (11.7 x 2.7 x 7.3 in.)	1.4 (3.0)	Back-panel
1771-AM2	I/O chassis with integral remote I/O adapter and power supply (3 A available for I/O modules)	1 slot	298 x 130 x 187 mm (11.7 x 5.1 x 7.3 in.)	2.3 (5.0)	Back-panel

Mounting Dimensions

Minimum Spacing Requirements for a Controller-resident Chassis

- Mount the I/O chassis horizontally.
- Allow 153 mm (6 in.) above and below the chassis.
- Allow 102 mm (4 in.) on the sides of each chassis.
- Allow 51 mm (2 in.) vertically and horizontally between any chassis and the wiring duct or terminal strips.
- Leave any excess space at the top of the enclosure, where the temperature is the highest.

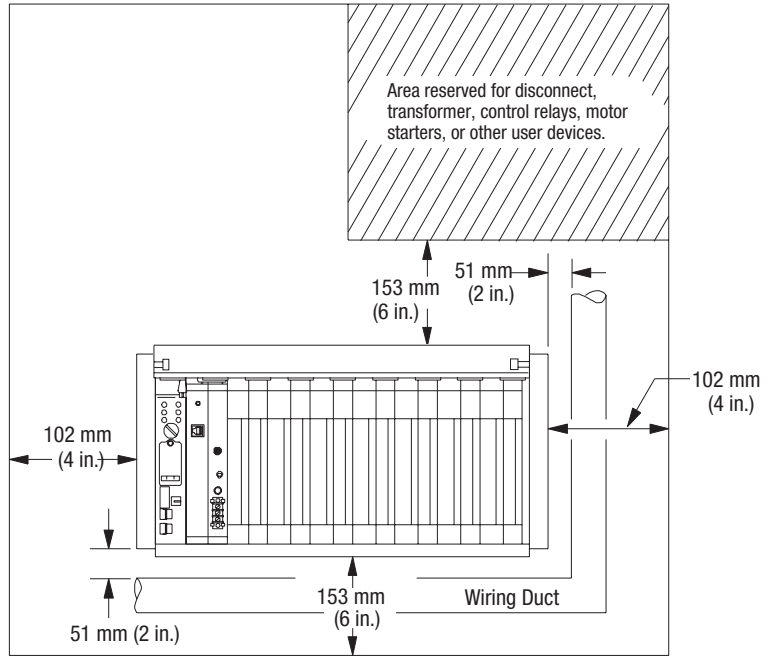

Minimum Spacing Requirements for a Remote I/O and Extended-local I/O Chassis

- Mount the I/O chassis horizontally.
- Allow 153 mm (6 in.) above and below all chassis. When you use more than one chassis in the same area, allow 152.4 mm (6 in.) between each chassis.
- Allow 102 mm (4 in.) on the sides of each chassis. When you use more than one chassis in the same area, allow 101.6 mm (4 in.) between each chassis.
- Allow 51 mm (2 in.) vertically and horizontally between any chassis and the wiring duct or terminal strips.
- Leave any excess space at the top of the enclosure, where the temperature is the highest.

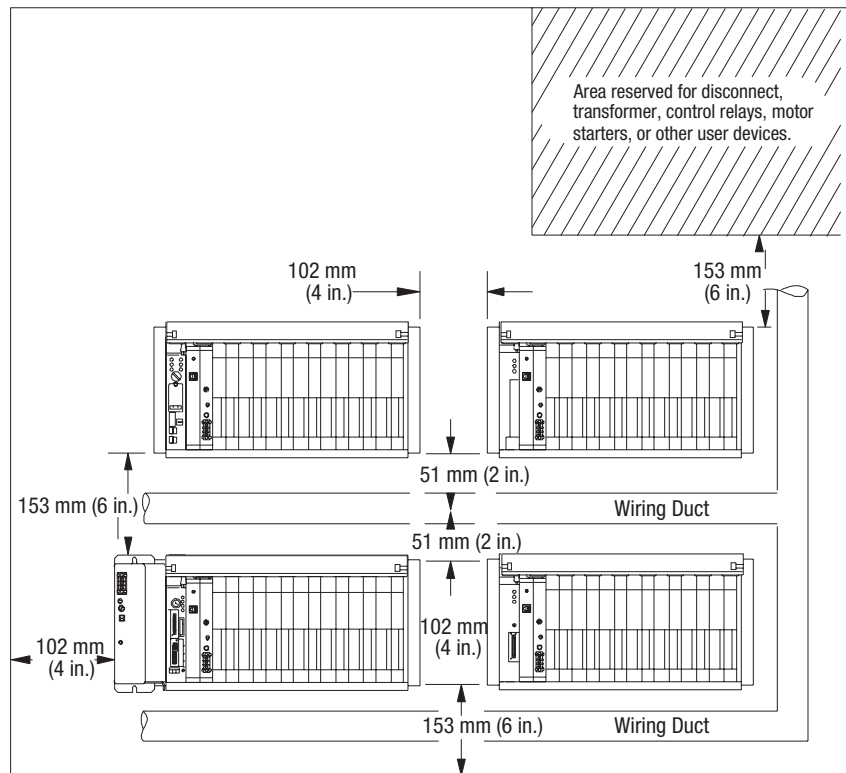

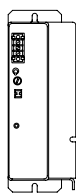

Select Power Supplies

Step 5 - Select:

- One power supply for each chassis

The 1771 power supplies provide 5V dc power directly to the chassis backplane. These power supplies occupy one or two slots in a 1771 chassis and can provide up to 8 A per supply to the I/O chassis.

These power supplies require no space outside the chassis, except for the 1771-P7P power supply. The 1771 power supplies connect directly to the chassis backplane and can be paralleled to provide greater current. Redundancy is available for greater availability.

Cat. No.	Input Voltage, Nom	Input Voltage Range	Real Input Power, Max	Apparent Input Power, Max	Transformer Load, Max	User Output Current	Backplane Output Current	Frequency	Location, No. of Slots
1770-P1	120V ac or 220/240V ac	105-125V ac 205-250V ac	20 W	37V A	50V A	300 mA @ +5V dc +150 mA @ +15Vdc -150 mA @ 15V dc	N/A	50...440 Hz	Standalone
1771-P4S	120V ac	97-132V ac	59 W	89V A	148V A	none	8 A @ +5V dc	47...63 Hz	1771 Chassis, 1 slot
1771-P5	24V dc	20.5-30V dc	57 W	N/A	N/A	none	8 A @ +5V dc	dc/Rect sine	1771 Chassis, 2 slots
1771-P5E	24V dc (has selectable power-loss delay)	20.5-30V dc	57 W	N/A	N/A	none	8 A @ +5V dc	dc/Rect sine	1771 Chassis, 2 slots
1771-P4S1	100V ac	85-120V ac	56 W	89V A	140V A	none	8 A @ +5V dc	47...63 Hz	1771 Chassis, 1 slot
1771-P6S1	200V ac	170-240V ac	56 W	89V A	140V A	none	8 A @ +5V dc	47...63 Hz	1771 Chassis, 1 slot
1771-P4R	120V ac	97-132V ac	59 W	92V A	148V A	none	8 A @ +5V dc	47...63 Hz	1771 Chassis, 1 slot
1771-P6R	220V ac	194-264V ac	59 W	92V A	148V A	none	8 A @ +5V dc	47...63 Hz	1771 Chassis, 1 slot
1771-P6S	220V ac	194-264V ac	56 W	89V A	140V A	none	8 A @ +5V dc	47...63 Hz	1771 Chassis, 1 slot
1771-P7	120V ac or 220V ac	97-132V ac 195-264V ac	108 W	176V A	270V A	none	16 A @ +5V dc	47...63 Hz	Standalone
1771-PS7	120V ac or 220V ac	97-132V ac 195-264V ac	171 W	257V A	427V A	8 A @ 5V dc 2 A @ 15V dc 2 A @ -15V dc 2.5 A @ 24V dc	16 A @ +5V dc (total output power including user is 100 W max)	47...63 Hz	Standalone
1771-P10	125V dc	97-145V dc	51 W	N/A	N/A	none	8 A @ +5V dc	dc/Rect sine	1771 chassis, 2 slots

For more information, see the 1771 I/O Chassis and Power Supplies Product Data, publication 1771-2.185.

Power Requirements and Transformer Sizing

Each ac input power supply generates a shutdown signal on the backplane whenever the ac line voltage drops below its lower voltage limit. It removes the shutdown signal when the line voltage comes back up to the lower voltage limit. This shutdown is necessary so that only valid data is stored in memory.

The external transformer rating (V A) of each power supply is greater than its real input power (W) because a capacitor-input ac/dc supply draws power only from the peak of the ac voltage wave form. If the transformer is too small, it clips the peak of the sine wave, when the voltage is still above the lower voltage limit. The power supply will sense this clipped wave form as low voltage and could prematurely shut down modules in the chassis.

The following Power Load and Transformer Sizing graphs display the backplane power load on the vertical axis.

Since these supplies have multiple outputs, the backplane power load is given in watts.

- Use the real power value (W) for determining the amount of heat dissipation you will have inside the enclosure.
- Use the apparent power value (V A) for estimating power distribution sizing.
- Use the transformer load value (V A) of each power supply plus all other loads on a transformer to determine the required transformer size.

Power Load and Transformer Sizing

1771-P4S, -P6S,
-P4S1, -P6S1
ac/dc

Backplane
Current Load
(A)

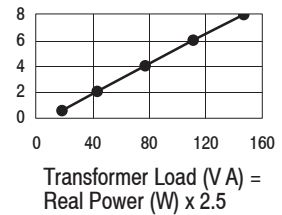
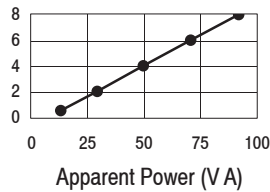
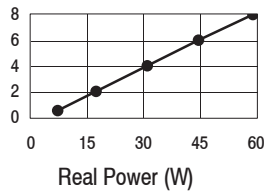

1771-P4R, -P6R
ac/dc
1 Unit

Backplane
Current Load
(A)

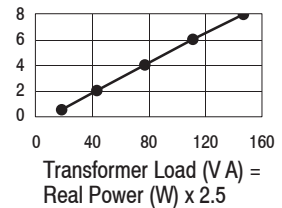
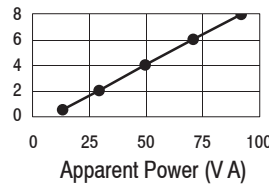
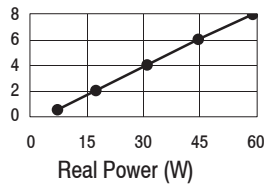

1771-P4R, -P6R
ac/dc
2 Units

Backplane
Current Load
(A)

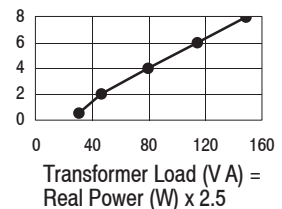
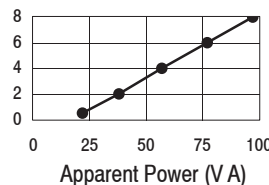
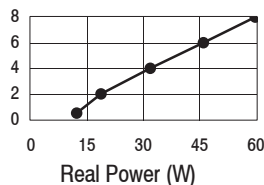

1771-P4R, -P6R
ac/dc
3 Units

Backplane
Current Load
(A)

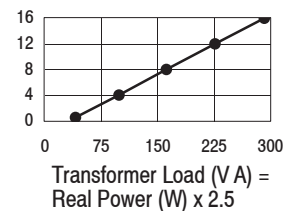
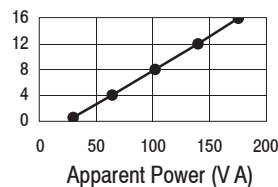
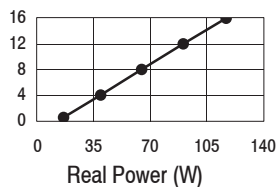

1771-P4R, -P6R
ac/dc
4 Units

Backplane
Current Load
(A)

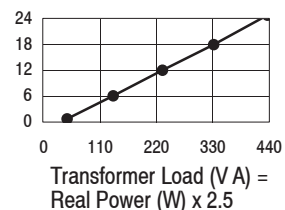
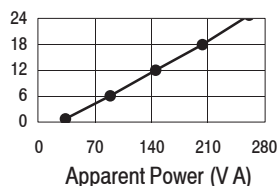
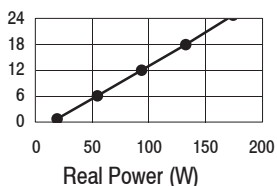

1771-P5, -P5E
dc/dc

Backplane
Current Load
(A)

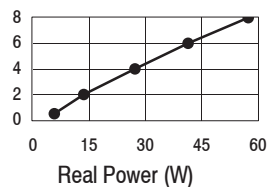

1771-P7
ac/dc

Backplane
Current Load
(A)

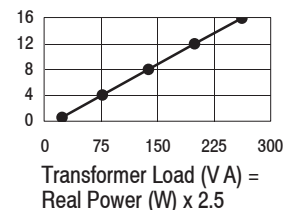
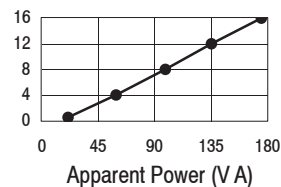
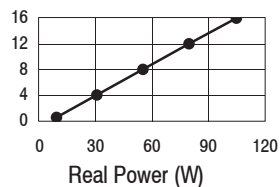

1771-PS7
ac/dc

Backplane
Current Load
(A)

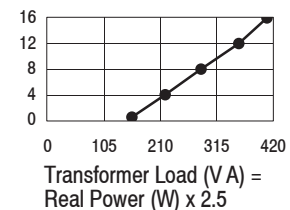
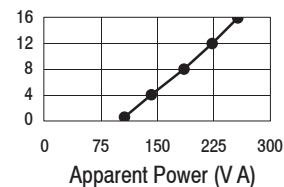
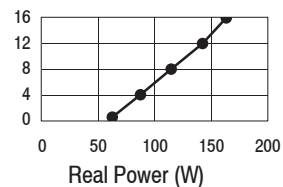

1771-P10
dc/dc

Backplane
Current Load
(A)

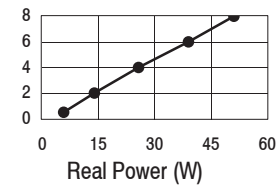

Notes

Step 6 - Select:

- RSLogix 5 Programming Software
- RSLinx Software
- RSNetWorx Network Configuration Software
- RSLogix Emulate 5 Emulation Software
- PLC-5 Controller and Training Software
- ViewAnyWare Products

Select Software

Your selection of communication modules and network configuration determines what software packages you need to configure and program your system.

The PLC-5 controllers support multiple industry-standard programming languages. You can program in structured text, function block, sequential function charts, or ladder logic. This versatility means you can maintain and troubleshoot programs in the same language that you develop them.

To use a	You need	Order this cat. no.
PLC-5 Programmable Controller	RSLogix 5 software	9234-RL5300ENE
PLC-5 Programmable Controller on ControlNet	RSLogix 5 software with RSNetWorx for ControlNet software	9234-RWCNTENE (RSLogix 5 software plus RSNetWorx for ControlNet software)
1771-SDN DeviceNet Scanner Module	RSLogix 5 software with RSNetWorx for DeviceNet software	9234-RL5300NXENE (RSLogix 5 software plus RSNetWorx for DeviceNet software)
PLC-5-based system you want to emulate	RSLogix Emulate 5 software	9324-RL350END (RSLogix 5 software plus RSLogix Emulate 5 software)
Operator interface	RSView32 software	ViewAnyWare products (see page 51)
PLC-5 single software solution for all your PLC-5 software needs	RSLogix 5 Professional software with ControlNet, DeviceNet and EtherNet/IP	9324-RL5700NXENE

Programming Software

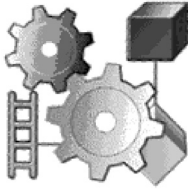

Use RSLogix 5 programming software to configure 1771 I/O and communication modules and to program the PLC-5 programmable controller. RSLogix 5 software offers relay ladder, structured text, function block diagram, and sequential function chart editors for you to develop application programs.

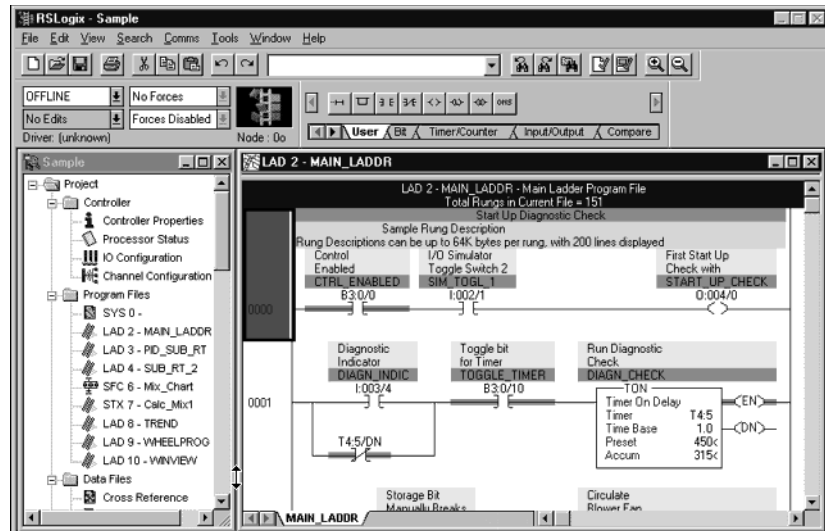

RSLogix 5 Software Requirements

Description	Min	Recommended
Personal computer	Intel Pentium II or greater	Intel Pentium III 700 MHz
Software requirements	Supported: <ul style="list-style-type: none"> • Microsoft Windows XP • Microsoft Windows 2000 • Microsoft Windows ME 	
RAM	128 MB	256 MB
Hard disk space	70 MB (or more, based on application requirements)	
Video requirements	256-color VGA graphics adapter, 800 x 600 resolution	True Color 1024 x 768 resolution

RSLinx Software

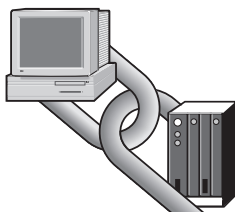

RSLinx software, 9355 series, is a communication server package that provides plant-floor device connectivity for a wide variety of applications. RSLinx software can support multiple software applications simultaneously communicating to a variety of devices on many different networks.

RSLinx software provides a user-friendly graphical interface for navigating through your network. Select a device and click to access a variety of integrated configuration and monitoring tools. A complete set of communication drivers is provided for your networking needs, including Allen-Bradley networks.



RSLinx software is available in multiple packages to meet the demand for a variety of cost and functionality requirements.

RSLinx System Requirements

Description	Value
Personal computer	Intel Pentium 100 MHz (faster processor improves performance)
Software requirements	Supported: <ul style="list-style-type: none"> • Microsoft Windows XP • Microsoft Windows 2000 • Microsoft Windows NT version 4.0 with Service Pack 3 or greater • Microsoft Windows ME • Microsoft Windows 98
RAM	32 MB min 64 MB recommended
Hard disk space	35 MB (or more, based on application requirements)
Video requirements	16-color VGA graphics display, 800 x 600 or greater resolution

In most cases, RSLinx Lite software comes bundled with controller programming packages.

Network Configuration Software

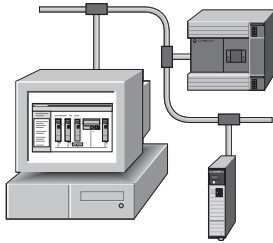

Use RSNetWorx for ControlNet (9324-CNETL3) and RSNetWorx for DeviceNet (9324-DNETL3) software to configure and schedule tools for your ControlNet or DeviceNet networks. RSNetWorx software lets you create a graphical representation of your network configuration and configure the parameters that define your network.

RSNetWorx for ControlNet software schedules network components. The software automatically calculates network bandwidth for the entire network, as well as the bandwidth used by each network component. You must have RSNetWorx software to configure and schedule the ControlNet networks in your PLC-5 programmable controller system.

RSNetWorx for DeviceNet software configures the DeviceNet I/O devices and creates the scan list. The 1771-SDN DeviceNet scanner module stores the configuration information and scan list.

RSNetWorx System Requirements

Description	ControlNet	DeviceNet	EtherNet/IP
Personal computer	Intel Pentium or Pentium-compatible		
Software requirements	Supported: <ul style="list-style-type: none"> • Microsoft Windows XP • Microsoft Windows 2000 Terminal Server • Microsoft Windows NT version 4.0 with Service Pack 6 or later • Microsoft Windows ME • Microsoft Windows 98 		
RAM	32 MB min more memory is required for large networks		
Hard disk space	Min: 115 MB (includes program files and hardware files) Full support: 168...193 MB (includes program files, online help, tutorial, and hardware files)	Min: 190 MB (includes program files and hardware files) Full support: 230...565 MB (includes program files, online help, tutorial, and hardware files)	Min: 108 MB (includes program files and hardware files) Full support: 115...125 MB (includes program files, online help, tutorial, and hardware files)
Video requirements	16-color VGA graphics adapter, 640 x 480 resolution min, 800 x 600 resolution recommended		
Other	RSLinx Lite software 2.4 or later to use RSNetWorx online	RSLinx Lite software 2.4 or later to use RSNetWorx online	RSLinx Lite software 2.41 or later to use RSNetWorx online

RSLogix Emulate 5 Software

RSLogix Emulate 5 software (9324-RL5350END) is the emulation package for the PLC-5 programmable controllers. RSLogix Emulate 5 software used in conjunction with RSLogix 5 software lets you run and debug your application code while at your computer. In addition, RSLogix Emulate 5 software also lets you test HMI screens, developed in RSView32 for example, without the need to connect to a real controller.

By using RSLogix Emulate 5 software, you can eliminate the cost for dedicated test ware, improve your productivity, and reduce the time to market of your products.

RSLogix Emulate 5 software gives you enhanced debug capabilities. You can set tracepoint and breakpoint instructions, ladder diagram only, in your application code, use traces, and also vary the execution speed of the emulator. RSLogix Emulate 5 software supports all the programming languages, ladder diagram, function block diagram, structured text, and sequential function chart. RSLogix Emulate 5 software does not allow control of real I/O.

RSLogix Emulate 5 System Requirements

Description	Value
Personal computer	IBM-compatible Intel Pentium II 300 MHz or Celeron 300A (Pentium III 600 MHz recommended)
Software requirements	Supported: <ul style="list-style-type: none"> • Microsoft Windows XP with Service Pack 1 or later • Microsoft Windows 2000 with Service Pack 2 or later • Microsoft Windows NT version 4.0 with Service Pack 6A or later
RAM	128 MB min
Hard disk space	50 MB
Video requirements	16-color VGA graphics display, 800 x 600 or greater resolution

PLC-5 Controller and Training Software

Rockwell Automation offers several different levels of training for your PLC-5 programmable controller system. While most of these training aids are PLC-5 specific, the lessons and tools also apply to other platforms.

- Instructor-based Training
- Computer-based Training
- Workstation Simulator
- Job Aids

Instructor-based Training

The instructor-based courses are best suited for people new to the PLC-5 architecture and for those new to programmable controllers.

Course Number	Description
CCPS65	SLC 500/PLC-5 Communications
CCP409	PLC-5 Advanced Maintenance & Troubleshooting
CCP504	RSLogix 5/500 Software
CCP412	PLC-5 Maintenance & Troubleshooting
CCP410	PLC-5 Programming
CCP411	PLC-5 Advanced Programming
CCP122	PLC-5/SLC 500 Fundamentals Using RSLogix software

Computer-based Training

The computer-based training programs are designed to provide the essential introductory information needed for using the product. Computer-based training is best used as a resource following an instructor-based course.

Course Title	Description
RSTrainer 2000 for RSLinx Software	Detailed instruction of RSLinx software and its communication capabilities
RSTrainer 2000 for RSLogix 5 software	Teaches ladder-logic development, documentation, and troubleshooting using RSLogix 5 software

1771 I/O Rack System Workstation

The PLC-5 workstation simulator (ABT7TDPLC1) is an engineering support tool that you can integrate into your training and development program. Designed for use with the Universal I/O Simulator, this rugged workstation precisely simulates the mid-size PLC-5 controller, and other programmable controller families. The simulator includes:

- PLC-5/40 Controller
- 12-slot I/O Chassis
- Single-slot Power Supply
- Digital I/O Modules
- 3 High-density 10-30V DC Input Modules
- 3 High-density 10-60V DC Output Modules
- Intelligent I/O Modules
- 1 Analog Input Module
- 1 Analog Output Module
- 3 Empty Chassis Slots
- Hard-shell Shipping Case

Job Aids

Job aids are useful resources to use in your facility after completing instructor-based and computer-based training.

Job Aid	Description
ABT-1785-TSJ53	RSLogix 5 software, version 4.0, Procedures Guide for PLC-5 Systems
ABT-1785-DRG70	PLC-5 Documentation Reference Guide
ABT-1785-TSJ22	PLC-5 Troubleshooting Guide Using RSLogix 5 Series Software

ViewAnyWare Products

ViewAnyWare products, together with Logix for control and NetLinx architecture for communication, make up Rockwell Automation's Integrated Architecture strategy. The ViewAnyWare strategy combines Rockwell Automation's expertise in Allen-Bradley electronic operator interface and industrialized PC hardware with Rockwell Software's supervisory control software. Current ViewAnyWare products include:

- RSVIEW Enterprise Series software.
- PanelView Plus operator interface.
- VersaView industrial computers and monitors.
- VersaView CE industrial computer.

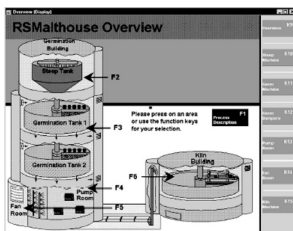

RSVIEW Enterprise Series Software

RSVIEW Enterprise Series software from Rockwell Software is a line of HMI software products designed with a common look, feel, and navigation to help speed HMI application development and training time. With RSVIEW Enterprise software, version 3.0, you can reference existing Logix data tags. Any changes made to these referenced tags are automatically inherited by RSVIEW software.

- RSVIEW Studio software lets you create applications in a single design environment. It configures Supervisory Edition, Machine Edition, VersaView CE, and PanelView Plus products. It supports editing and reusing projects for improved portability between embedded machine and supervisory HMI systems, saving development time and reducing engineering and training costs.
- RSVIEW Machine Edition (ME) software is a machine-level HMI product that supports both open and dedicated operator interface solutions. It provides a consistent operator interface across multiple platforms (including Microsoft Windows CE, Windows 2000/XP, and PanelView Plus solutions) and is ideal for monitoring and controlling individual machines or small processes.
- RSVIEW Supervisory Edition (SE) software is an HMI product for supervisory-level monitoring and control applications. It has a distributed and scalable architecture that supports distributed-server/multi-user applications. This highly-scalable architecture can be applied to a standalone, one-server/one-user application or to multiple users interfacing with multiple servers.

The following table describes available RSVIEW Enterprise Series products.

RSView Enterprise Series Product Line	Cat. No.	Description
RSView Studio software	9701-VWSTENE	RSView Studio for RSVIEW Enterprise Series
	9701-VWSTMENE	RSView Studio for Machine Edition
RSView Machine Edition software	9701-VWMR015AENE	RSView ME Station runtime for Windows 2000, 15 displays
	9701-VWMR030AENE	RSView ME Station runtime for Windows 2000, 30 displays
	9701-VWMR075AENE	RSView ME Station runtime for Windows 2000, 75 displays
RSView Supervisory Edition software	9701-VWSCWAENE	RSView SE client
	9701-VWSCRAENE	RSView SE view client
	9701-VWSS025AENE	RSView SE server 25 displays
	9701-VWSS100AENE	RSView SE server 100 displays
	9701-VWSS250AENE	RSView SE server 250 displays
	9701-VWSS000AENE	RSView SE server unlimited display
	9701-VWB025AENE	RSView SE station 25 displays
	9701-VWB100AENE	RSView SE station 100 displays
	9701-VWB250AENE	RSView SE station 250 displays
	9701-VWSB000AENE	RSView SE station unlimited display

PanelView Plus Operator Interface



PanelView Plus software is ideal for applications with a need to monitor, control and display information graphically, allowing operators to quickly understand the status of their application. PanelView Plus software is programmed with RSVIEW Studio software and has embedded RSVIEW Machine Edition software functionality. It combines the best features from the popular Allen-Bradley PanelView Standard and PanelView e operator interface products and adds new functionality including:

- multi-vendor communications.
- trending.
- expressions.
- data logging.
- animation
- RSVIEW Studio software direct browsing of RSLogix 5000 addresses.



VersaView Industrial Computers and Monitors

VersaView is a family of industrial computer and monitor solutions, comprised of integrated display computers, workstations, non-display computers, and flat panel monitors. VersaView products offer effortless management of changing technology, a rugged but cost-effective design, and easier product configuration. All VersaView products provide the latest industrial solutions available, optimized for visualization, control, information processing, and maintenance application. RSVIEW ME, RSVIEW SE client, and RSVIEW SE server runtimes are installed. Separate activation is required.

VersaView CE Industrial Computers



VersaView CE software is an open Windows CE terminal with a Windows desktop environment - bringing together features of operator interfaces and industrial computers. It is a high-performance computer with a compact flash drive and integrated RSVIEW Machine Edition runtime, with no activation required. There's no hard disk, no fan, and no moving parts which means maximum reliability on the plant floor. Easy to set up and maintain, VersaView CE software means an open system that's rugged and economical, offering high functionality in an easy to use package.

MobileView Portable HMI



The MobileView family of portable HMI products lets you move a machine around or down a production line throughout the entire plant, resulting in greater worker and plant productivity. The MobileView interfaces let you have information and machine control wherever it is required. MobileView Machine and MobileView Guard terminals are available with RSVIEW Machine Edition software running locally, eliminating the need for a server. MobileView terminals act as thin clients to computer applications, such as RSVIEW Supervisory Edition software, to easily integrate into new or existing control architectures.

Summary

Use a spreadsheet to record the amount and type of devices your PLC-5 system needs. For example, this sample system could result in the PLC-5 system spreadsheet.

Example PLC-5 System

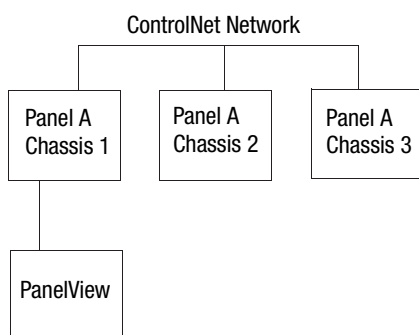

PLC-5 System Spreadsheet

Device	Number of I/O Points Needed	Cat. No.	I/O Points per Module	Number of Modules
120V ac digital inputs	76	1771-IAD	16	5
120V ac digital outputs	27	1771-OD16	16	2
24V dc digital inputs	40	1771-IQ	8	5
24V dc digital outputs	13	1771-OB	8	2
contact digital outputs	10	1771-OW16/B	16	1
4...20 mA analog inputs	6	1771-NIS	8	1
±10V dc analog inputs	3	1771-NOV	8	1
4...20 mA analog outputs	4	1771-OFE2	4	1
PanelView terminal	na	2711 Series	na	na
ControlNet PLC-5 controller	na	1785-L40C15	na	na
PanelView terminal	na	2711 Series	na	na
Total				18

As you select devices for your PLC-5 system, keep in mind the sections/steps in this selection guide:.

Step	Select	From
1	I/O	<ul style="list-style-type: none"> • 1771 I/O Modules • 1746 I/O Modules • 1794 FLEX I/O Modules • 1797 FLEX Ex I/O Modules • 1791D CompactBlock I/O Modules • Encompass Partner Program I/O Modules
2	Networks	<ul style="list-style-type: none"> • EtherNet/IP Protocol • ControlNet Network • DeviceNet Network • Serial Network • Data Highway Plus • Remote I/O
3	Controllers	<ul style="list-style-type: none"> • Enhanced PLC-5 Controllers • Ethernet PLC-5 Controllers • ControlNet PLC-5 Controllers • Protected PLC-5 Controllers • EEPROM Memory Modules • Replacement Batteries
4	Chassis	<ul style="list-style-type: none"> • Chassis with the number of slots you need • Chassis that meet your power supply requirements • Chassis that meet your panel size and space limitations
5	Power Supplies	<ul style="list-style-type: none"> • One power supply for each chassis
6	Software	<ul style="list-style-type: none"> • RSLogix 5 Programming Software • RSLinx Software • RSNetWorx Network Configuration Software • RSLogix Emulate 5 Emulation Software • PLC-5 Controller and Training Software • ViewAnyWare Products

As you determine placement of the modules you need, use the worksheet on page 55 to record your choices. Make a copy of this worksheet for each chassis.

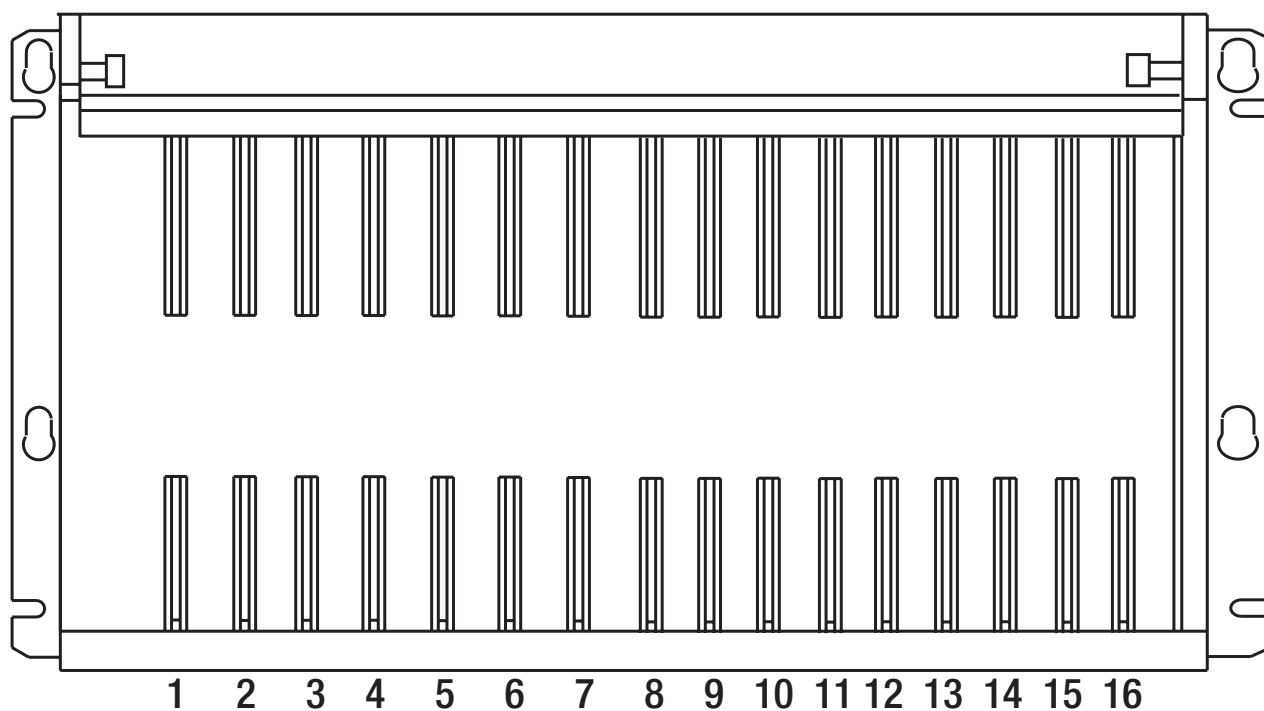

Chassis	Cat. No.	Inputs and Outputs	Voltage	Voltage and Current Range	Backplane Current Load
Rack					
Power					
1					
2					
3					
4					
5					
6					
7					
8					
9					
10					
11					
12					
13					
14					
15					
16					
		Totals			

Notes

The PLC-5 controller supports multiple industry-standard programming languages. You can program logic in IEC 1131-based structured text, function block, and built-in ladder logic instructions.

Instruction Set

Instruction Family	Description
Relay-type	The bit (relay-type) instructions monitor and control the status of bits. XIC, XIO, OTE, OTL, OTU, IIN, IOT, IDI, IDO
Timer and Counter	The timer and counter instructions control operations based on time or the number of events. TON, TOF, RTO, CTU, CTD, RES
Compare	The compare instructions compare values by using an expression or a specific compare instruction. CMP, EQU, GEQ, GRT, LEQ, LES, LIM, MEQ, NEQ
Compute	The compute/math instructions evaluate arithmetic operations using an expression or a specific arithmetic instruction. CPT, ACS, ADD, ASN, ATN, AVE, CLR, COS, DIV, LN, LOG, MUL, NEG, SIN, SQR, SRT, STD, SUB, TAN, XPY
Logical	The logical instructions perform logical operations on bits. AND, NOT, OR, XOR
Conversion	The conversion instruction convert integer and BCD values or convert radian and degree values. TOD, FRD, DEG, RAD
Bit Modify Move	The move instructions modify and move bits. BTD, MOV, MVM
File	The file instructions perform operations on file data and compare file data. FAL, FSC, COP, FLL
Diagnostic	The diagnostic instructions compare data to help you detect problems. FBC, DDT, DTR
Shift	Use the shift instructions to modify the location of data within files. BSL, BSR, FFL, FFU, LFL, LFU
Sequencer	Sequencer instructions monitor consistent and repeatable operations. SQO, SQI, SQL
Program Control	Program flow instructions change the flow of ladder program execution. MCR, JMP, LBL, FOR, NXT, BRK, JSR, SBR, RET, TND, AFI, ONS, OSR, OSF, SFR, EOT, UIE, UID
Process Control	The process control instruction provides closed-loop control. PID
Block-transfer	The block-transfer instructions transfer words to or from other devices. BTR, BTW, CIO
Message	The message instruction reads or writes a block of data to another station. MSG
ASCII	The ASCII instruction read, write, compare, and convert ASCII strings. ABL, ACB, ACI, ACN, AEX, AHL, AIC, ARD, ARL, ASC, ASR, AWA, AWT

See the Product Certification link at <http://www.rockwellautomation.com/products/certification> for Declarations of Conformity, Certificates, and other certification details.

Allen-Bradley, ControlLogix, Compact I/O, CompactBlock I/O, Data Highway Plus, DH+, Encompass, FLEX Ex, FLEX I/O, MicroLogix, PLC-5, PanelBuilder, PanelView, PanelView Plus, Rockwell Automation, RSLinx, RSLinx Gateway, RSGuardian, RSLogix, RSLogix 5, RSLogix 500, RSLogix 5000, RSLogix Emulate, RSNetWorx, RSNetWorx for ControlNet, RSTestStand, RSTrainer, RSView Machine Edition, RSView, RSView Supervisory Edition, SLC 500, VersaView, and ViewAnyWare are trademarks of Rockwell Automation, Inc.

Trademarks not belonging to Rockwell Automation are property of their respective companies.

www.rockwellautomation.com

Power, Control and Information Solutions Headquarters

Americas: Rockwell Automation, 1201 South Second Street, Milwaukee, WI 53204-2496 USA, Tel: (1) 414.382.2000, Fax: (1) 414.382.4444

Europe/Middle East/Africa: Rockwell Automation, Vorstlaan/Boulevard du Souverain 36, 1170 Brussels, Belgium, Tel: (32) 2 663 0600, Fax: (32) 2 663 0640

Asia Pacific: Rockwell Automation, Level 14, Core F, Cyberport 3, 100 Cyberport Road, Hong Kong, Tel: (852) 2887 4788, Fax: (852) 2508 1846